

Control box FSTronic DES-FS

**Designed for drives of rolling
fire shutters and sectional fire
gates**

CONTENT:

TECHNICAL REPORT

1. POWER SUPPLY
2. CONFIGURATION
3. INSTALLATION AND SETTING
4. CONNECTION OF OTHER EXTERNAL DEVICES
5. DESCRIPTION OF CONTROL AND TERMINAL BLOCKS
6. COUNTER OF CYCLES
7. VALUE REPORT
8. CONNECTORS
9. CONTROL PANEL
10. REGULAR SERVICE
11. CIRCUIT DIAGRAMS



manual for version: 3_0

1. Power supply

Casing size:	230 x 300 x 130 mm (W x H x D)
Weight:	2 kg
Installation:	vertically on the wall
Connection:	the inlets and outlets of the power and control circuits are via PG bushings on the underside of the switchboard
Voltage system:	3-N-PE, 50 Hz, 3x400/1x230V, TN-S
Input fusing:	3pcs of tube fuse 20x5 10A/F1500
Unit supply current:	0,3A without external devices and accumulators 0,6A without external devices and with charging of accumulators. Current under load acc. to size of motor
Operating voltage:	24 VDC
Output voltage for ext. devices:	max. 24 VDC/1,2A – max for each output see details of outputs – sum cannot exceed max. 1,2A
Output voltage for motor brake:	24 VDC/1,0A (with strongest motor need to be reduced amount of other accessories- limit max. 1,2A)
Output voltage for motor:	50 Hz, 3 x 400 VAC, 1 x 230 VAC
Control inputs:	24V/10mA for potential free contacts
Accumulators:	additional – up to 3 sets of 2pcs 12V/7-10Ah
Fusing of accumulators:	tube fuse F6,3A in transformer SCP-35-24
Operating temperature:	+10°C up to +35°C, at temperatures above + 25 ° C and below + 15 ° C the battery life decreases. Exceptionally, it can be operated at lower temperatures up to -5 ° C, provided that it is permanently connected to a power supply that provides heating of the circuits.
Air humidity:	max 93% without condensation
Degree of protection:	IP 54

Protection against electric shock is made according to ČSN 33 2000-4-41 by automatic disconnection of defective part from power supply and supplementary connection of safety circuits.

2. Configuration

FSTronic DES-FS is designed to control drive of rolling fire shutter – using motor FS designed with NES (mechanical end switches) or DES (digital end switches) produced by GfA, and using tubular motor FKB (NES) produced by BECKER.

Power supply of control circuits can be backed up by battery - in additional accessories it is battery module FS, which enables to keep gate in open position even during power failure. Batteries also secure power supply of all additional safety devices during gravitational closing after power failure. In case battery module is not connected, gravitational closing starts immediately after power failure. In case of connected battery module, gravitational

closing starts if the power supply is not restored and battery voltage drops below the limit 24,0V.

Operating panel and other equipment is placed inside the control box FSTronic DES-FS and wiring diagram for device connection is included in drawing documentation. Dimensions of control box FSTronic DES-FS are: 230x300x130mm (WxHxD), weight 2kg.

Inputs and outputs of power and control circuits are led through PG grommets on the underside of the control box.

Dimensions of battery module are:
200x250x100mm (WxHxD), weight 6kg

FSTronic DES-FS is connected to main switchboard by connection cable secured with auto fuse F 20A.

3. Installation and setting

Drive is pre-set and after connecting external control elements (controls and end switches) drive requires only control of function. Special attention should be given to the end switches functions. Their incorrect setting or electric connection can cause damage of mechanical part of gate. Before first putting into operation the mechanical part of gate installation has to be completely finished to avoid mechanical damage of gate when starting the motor. Before first putting into operation connect only:

1. Power cable – terminal block X1 terminals L1, L2, L3, N, PE

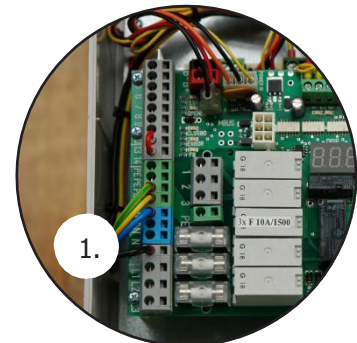

2. Motor cable – different cable according to the type of end switches DES/NES

2.1 motor – terminal block X1 terminals 1,2,3, N

2.2 motor brake – terminal block X1, terminals 4, 8 – **Connecting wires must not be wired in a wrong way (+ and -), polarity has to be checked – see scheme if connected wrongly gate will not close immediately when activated alarm!!!**

When gate does not close, reconnect correctly, move gate by motor and test fire alarm again

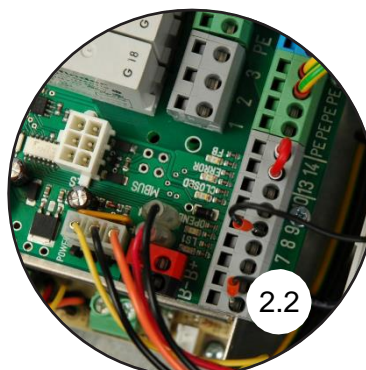
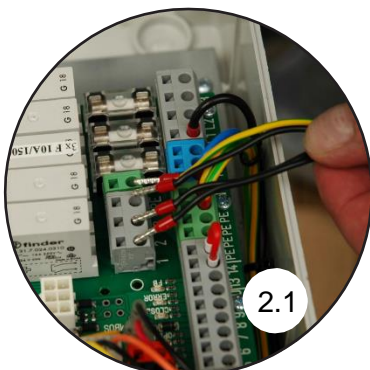

2.3 end switches - variant communication cable DES

2.4 end switches - variant NES – terminal block X1 - terminals 5,6,7,9,10

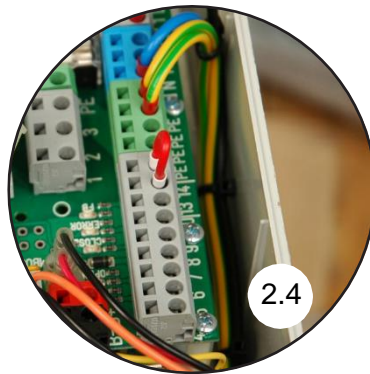

3. Connect terminals EPS – Fire contact (X2:+ and X:10) by default set as input NC contact - can be changed by parameter (default setting when this contact is open, the door is still in alarm). Originally supplied with the wire jumper marked "fire contact".

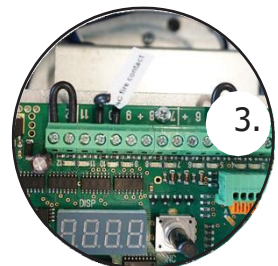

4. Connect terminals of safety brake (X1:13 a X1:14) NC contact (in case of disconnected contact, it is not possible to close the gate – safety contact of independent safety brake in case of chain drive)



5. Install key switch, due to transport it is delivered disassembled.

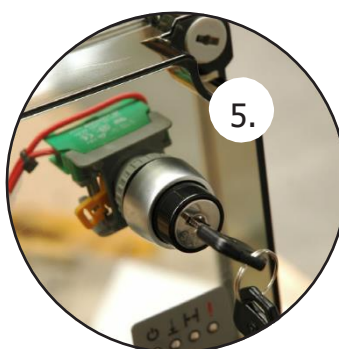
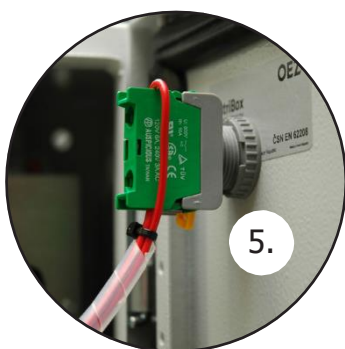

6. If battery module is part of the delivery, (X3:B+ and X3:B-) connect batteries to the control unit, battery is delivered with disconnected fuse, after connection insert fuse in battery module.

note – in case of connection of deeply discharged batteries can be control unit for short period out of functionality as all current is directed to basic battery recovery

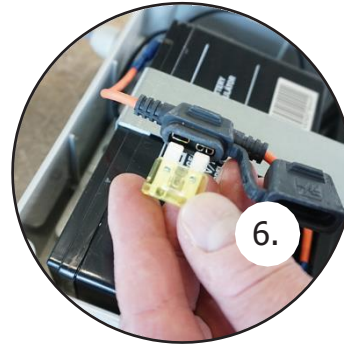
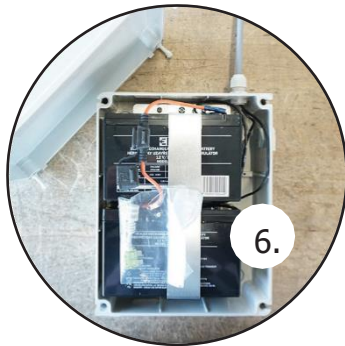

Do not connect any external controls or any other devices before setting the end switches – it can cause automatic start, which is not restricted due to the unset end switches.

3.1. Setting of end switches NES (mechanical)

In case of usage control box FSTronic DES-FS with mechanical end switches (NES), it is important to check connection of connector FUNC on printed circuit – A-B not connected = NES. (A-B connected = DES) see 5.1.

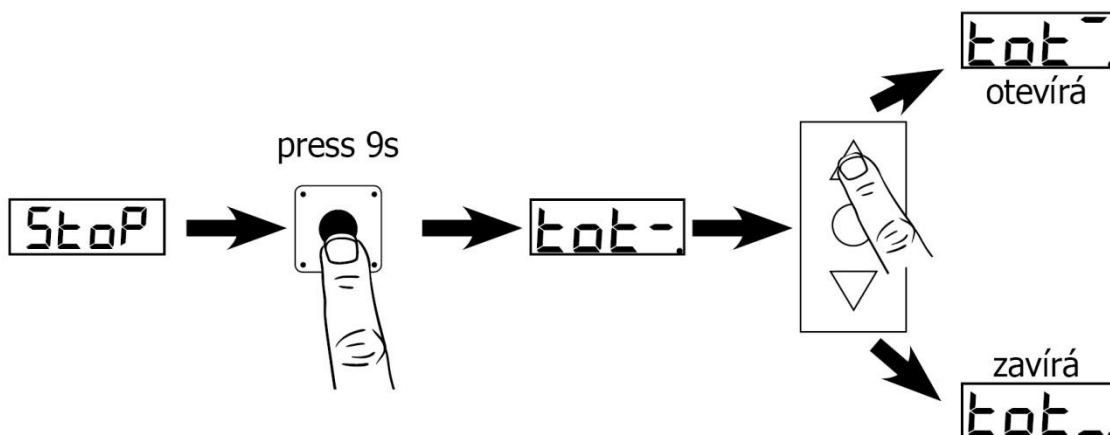

Setting of movement direction:

Setting is possible only from STOP state, "stop" must be shown on display.

1) press and hold knob button – during approx. 9 s. it passes to setting of movement, on display is written „ tot – “

(by holding the knob button, after 4 seconds there is at first displayed „Par“ it is necessary to hold the button until display shows "tot":

„tot – “

if there is pressed keyboard button "open" or "close", display shows:

a) tot ^ it is opening

b) tot _ it is closing

if the actual direction of movement is different, it is necessary to switch 2 cable phase conductors to motor

This function can be used for manual movement in emergency situations – only for service.

By manual movement (in function „tot“ by holding keyboard button) we set gate into required position Opened and Close, in which we can start to set mechanical end switches.

It is possible to skip setting of direction (dir/tot) by pressing knob button – to get directly to setting of end positions.

To put the gate into into operation, it is necessary to do final calibration of operation time. This is a safety function, which is important when preparing gate for standard operation.

To continue to calibration of time press knob.

Calibration of time:

It is essential to do the calibration of time exactly according to the description to avoid error, displayed EtEr error of movement time. This is a safety function, which controls time of movement during gate operation.

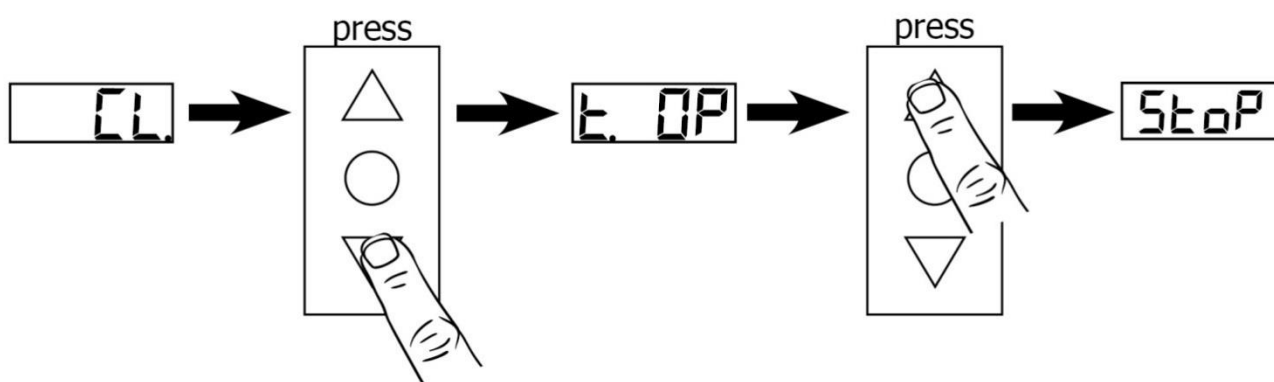

Setting of calibration:

It is important to set lower ("closed") and upper ("opened") end position.

1) display shows „CL“ - by pressing keyboard button CLOSE - to get to position "closed" (position "closed" has to be set).

- after setting the position "closed" the motor stops and display shows „t OP“

2) by pressing keyboard button OPEN and its holding (without interrupting) we get into position "opened" (position "opened" has to be set).

- in "opened" position the motor stops and unit goes to normal operation – setting of direction and positions is successfully completed

If the pressing/holding of keyboard button is interrupted before reaching the opened position, the setting automatically returns to point 1) and it is necessary to repeat the calibration process. You have to return to position "closed" and repeat the calibration process.

It is possible to terminate the calibration by pressing knob button – however, the calibration of time is not set and the unit cannot work automatically.

3.2 Setting of end switches DES (digital)

In case of usage control box FSTronic DES-FS with digital end switches (DES), it is important to check connection of connector FUNC on printed circuit – A-B connected = DES. (A-B not connected = NES) see 5.1

Setting of movement direction:

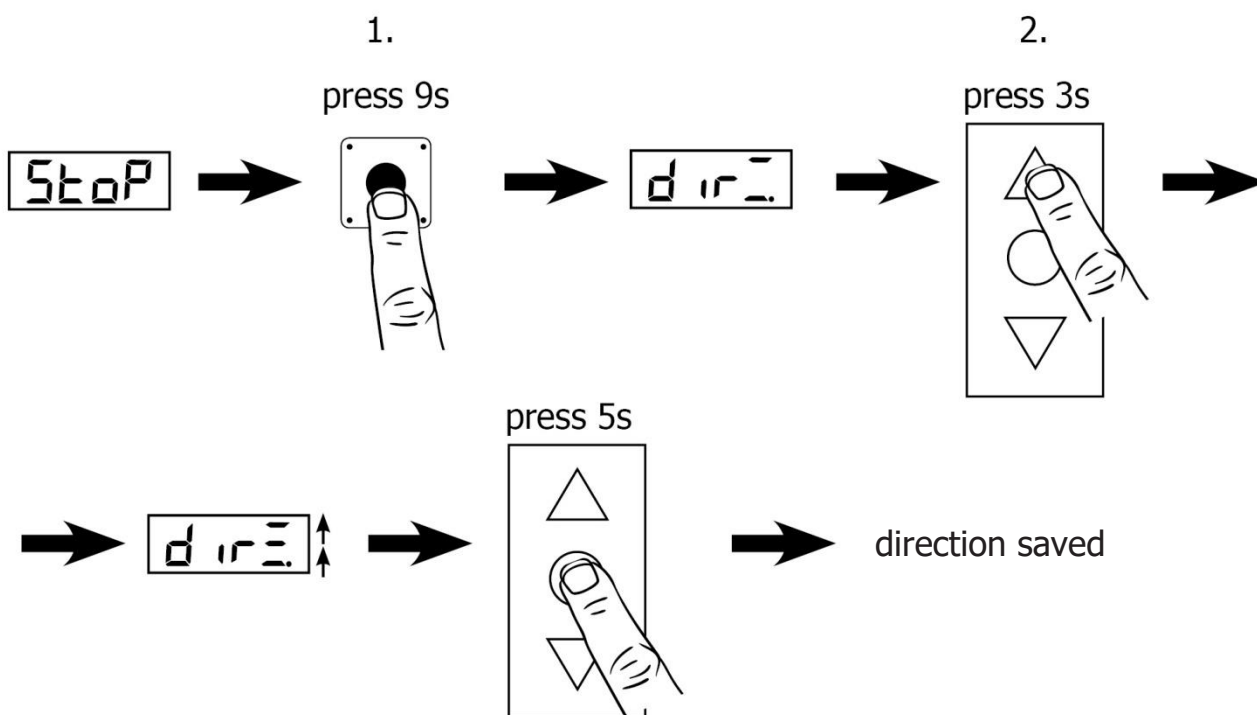

Setting is possible only from STOP state, "stop" must be shown on display.

1) press and hold knob button – during approx. 9 s. it passes to setting of movement, and display shows „ dir _“

(by holding the knob button, after 4 seconds there is at first displayed „Par“ it is necessary to hold the button until display shows "dir":

- a) „ dir _“ – if two horizontal lines light, the direction has been already set
- b) „ dir _“ – if two horizontal lines flash, the direction has not been set yet

2) Afterwards press keyboard buttons "open" or "close" (keyboard has to be unlocked by key switch), if the movement takes longer than 3 seconds, then three horizontal segments, shown on the display, start rolling in direction specified with keyboard. After releasing the button of movement direction, all three segments flashes:

- if the actual direction of movement is different, it is necessary to switch 2 cable phase conductors to motor and repeat point 2) setting of movement direction
- if the direction of movement corresponds, it is possible to save the setting – which can be done by pressing STOP button on keyboard and holding the button for 5 seconds.

After saving the direction of movement (by holding STOP on keyboard for 5 seconds) we automatically proceed to setting of end switches.

It is possible to skip setting of direction („dir“) by pressing knob button – to get directly to setting of end positions.

It is possible to use function „dir“ for manual movement of gate in emergency situations – only used for service (for example in case of getting out of range of end positions or during the activation of safety end switches).

Setting of upper end position „opened“:

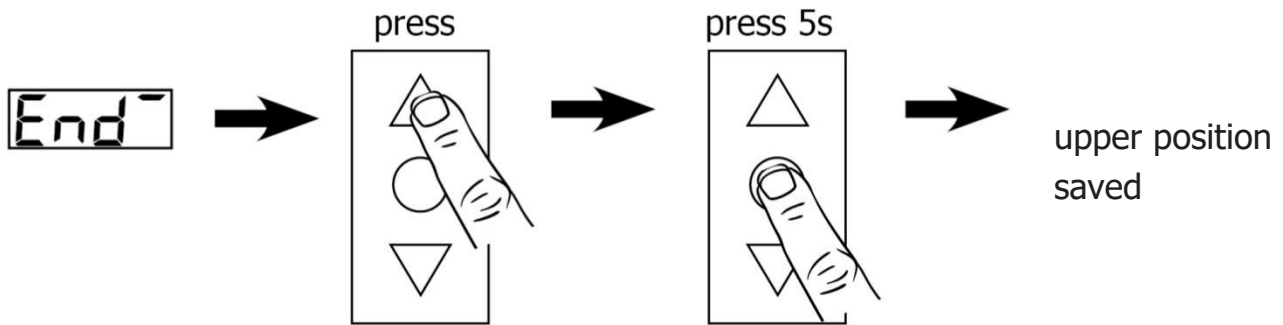

1) this setting is available automatically after saving the setting of direction or by pressing knob button, the display shows:

- a) „End -” – if the upper line lights, the position has been already set
- b) „End -” – if the upper line flashes, position has not been set yet

2) Afterwards press keyboard buttons OPEN or CLOSE (keyboard has to be unlocked by key switch) and move gate into position, in which we want to set the end position “opened”:

- If the actual position of gate corresponds with the required position, it is possible to save the setting – by pressing STOP button on keyboard and holding the button for 5 seconds.
- After saving the upper end position (by holding STOP on keyboard for 5 seconds) we automatically proceed to setting of middle position.
- It is possible to skip setting of upper end position (in case it has been already set) by pressing button knob – then we proceed directly to setting of middle position.

Setting of middle position:

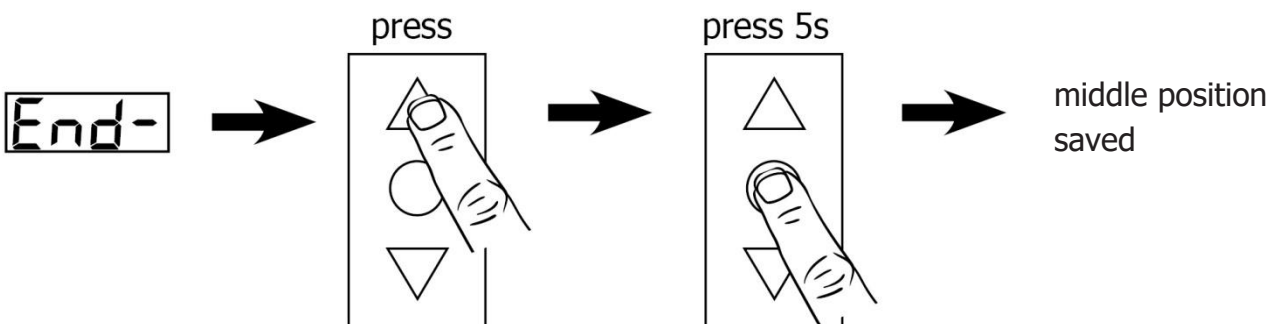

1) we can start setting of middle position after saving the position “opened” or by pressing button knob, there is displayed:

- a) „End -” – if the middle line lights up, the position has been already set
- b) „End -” – if the middle line flashes, position has not been set yet

2) Afterwards press keyboard buttons OPEN or CLOSE (keyboard has to be unlocked by key switch) and move gate into position, in which we want to set the middle position.

- If the actual position of gate corresponds with the required position it is possible to save the setting – by pressing STOP button on keyboard and holding the button for 5 s.
- After saving the middle position (by holding STOP on keyboard for 5 seconds), we automatically proceed to setting of lower end position.
- It is possible to skip setting of the middle position by pressing the knob button (if middle position has been already set correctly in between open and closed position) – and proceed to setting of the lower end position – it is necessary to set the middle position to put the gate into standard operation, the middle position is used for additional functions **(if not set or if set incorrectly out of traveling distance than it is not possible to finish setting of the control unit)**

Setting of lower end position „closed“:

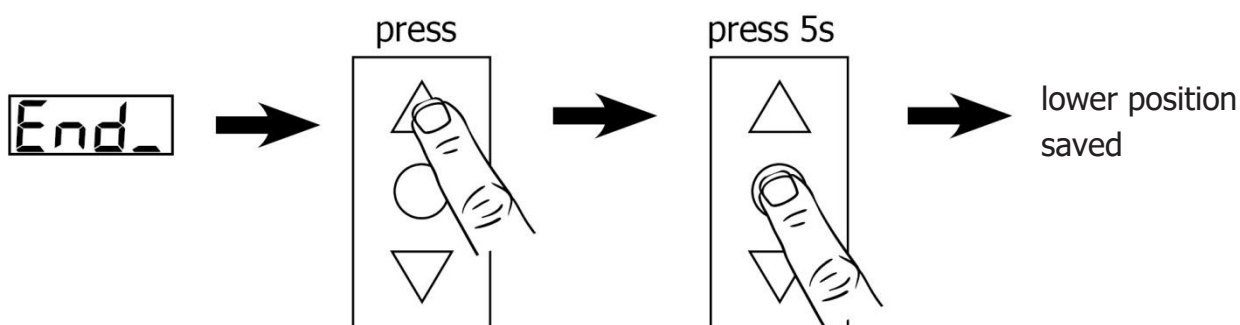

1) we can start setting of the lower end position after saving the middle position or by pressing the knob button, on display is shown:

- „End _“ – if the lower line lights, the position has been already set
- „End _“ – if the lower line flashes, the position has not been set yet

2) Afterwards press keyboard buttons OPEN or CLOSE (keyboard has to be unlocked by key switch) and move gate into position, in which we want to set the lower end position.

- If the actual position of gate corresponds with the required position it is possible to save the setting – by pressing STOP button on keyboard and holding the button for 5 seconds.
- After saving the lower end position (by holding STOP on keyboard for 5 seconds), we automatically proceed to calibration of opening time.
- It is possible to skip setting of the lower end position by pressing knob button – and proceed to setting of the calibration of opening time.

To put the gate into operation, it is necessary to do final calibration of operation time. This is a safety function, which is important when preparing gate for standard operation.

Calibration of time:

It is essential to do the calibration of time exactly according to the description to avoid error, displayed EtEr error of movement time. This is a safety function, which controls time of movement during gate operation.

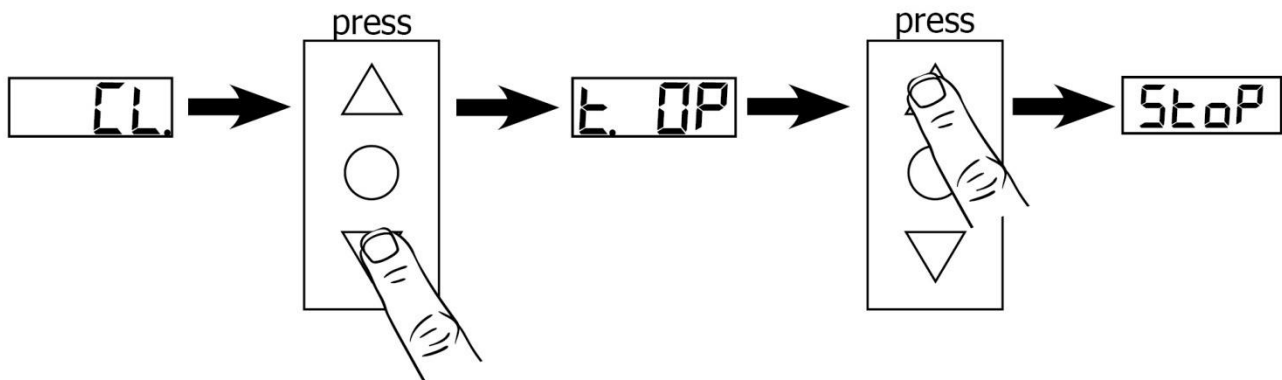

Setting of calibration:

It is important to set lower ("closed") and upper ("opened") end position (middle position must be set in between position opened and closed).

1) display shows „CL“ – by pressing keyboard button CLOSE – to get to position "closed" (position "closed" has to be set).

- after setting the position "closed" the motor stops and display shows „t OP“

2) by pressing keyboard button OPEN and its holding (without interrupting) we get into position "opened" (position "opened" has to be set).

- in "opened" position the motor stops and unit goes to normal operation – setting of direction and positions is successfully completed

If the pressing/holding of keyboard button is interrupted before reaching the opened position, the setting automatically returns to point 1) and it is necessary to repeat the calibration process. You have to return to position "closed" and repeat the calibration process.

It is possible to terminate the calibration by pressing knob button – however, the calibration of time is not set and the unit cannot work automatically.

Deleting of movement direction, end positions, calibration time:

Deleting is possible only from STOP state, on display must be shown 

Press and hold knob button – after approx. 20s the delete operation starts, on display is shown: 

a) if we press knob button – we return to STOP state without deletion

b) if we turn the knob, select YES and press knob button – the deletion is accomplished and we return to STOP

c) if we turn the knob, select ESC and press knob button – we return to STOP without deletion

4. Connection of other external devices

After testing the setting of end positions (DES or NES) it is possible to continue with connection of other external devices.

Control box FSTronic DES-FS is standardly equipped with keyboard buttons „Open“ and „Close“, which can be used to open the gate in “Dead man” mode. For automatic operation (one- press start) upwards, it is necessary to connect terminals X2:+ and X2:3 by connection or safety device.– if it is possible to hang on the surface of gate leaf or to pass an object through the gate, it is necessary to add a safety device “upper safety sensor” to maintain automatic operation.

Automatic operation downwards is activated by connecting safety sensor „lower safety sensor“ with terminals X2:+ and X2:2 („lower safety sensor“) or by connecting optical safety edge OSE with terminals X2:G and X2:W and X2:B. If the safety sensor is disconnected (or OSE or contact strip is activated) during closing, gate moves back and stops (see setting of DIP6 and selection of parameter „4“).

In case the „lower safety sensor“ is disconnected (or OSE or contact strip is activated) permanently, it is possible to close the gate in “Dead man” mode. “Lower safety sensor” has no influence on opening of gate. If in “Dead man” mode is during movement any safety device is deactivated and again activated than door stops and waits for another command.

It is also possible to connect safety contact strip of the system with closed loop by resistance (8,2k Ω) – this function is identical with the function of OSE or “lower safety sensor”. If the contact strip is not connected, terminals X2:39 and X2:40 has to be connected to resistance 8,2k Ω - without the resistance the automatic operation does not work.

When pull switch (X2:8) is activated, gate opens into the upper end position and remains in this position for a time set in parameter „6“, then the gate automatically closes.

Control Step-by-step (X2:7) enables to open and close gate with a single button. When we press the button, the gate starts to open to the end position or stops after we press the button again. When we do another press of the button, the gate starts to close to the end position or after another press of the button the gate stops. The gate can be stopped anytime with button STOP.

When EPS (fire alarm system) is activated – contact between X2:+ and X2:10 is disconnected and gate is in alarm mode = the gate immediately closes by gravity (if there is not set a closing time for delayed closing – pre-flash - see Parameter 2).

During power failure the gate immediately starts closing in case battery module is not connected. If the battery module is connected (terminals X3:B+ and X3:B-) gate remains in open position according to the setting of parameter „8“. If parameter „8“ is set on value „-“ ,i.e. influenced by battery capacity, the gate remains in the position for the time until battery voltage drops below the limit 24,0V (it depends on the battery condition and status of battery charge), then the gate closes into the lower end position like in alarm mode. If battery voltage drops below 22,0V control unit goes to sleeping mode.

During the alarm closing it is possible to stop the gate with STOP button– it is stopped as long as the button is held. The „lower safety sensor“ or optical safety edge OSE stops the closing without moving back. If the „lower safety sensor“ or optical safety edge OSE is activated for 10 sec (see setting of parameters and), the gate closes again

In case the gate is closed by signal from fire alarm, it is possible to do an emergency open into the middle position using button Emergency open (X2:9). In the middle position (set according to parameter "9") gate remains for the set time in parameter „A“, then it is closed like in alarm mode. A pre-flash is not set before this emergency open. The function only applies in case of present power supply 3x400V (1x230V).

Function of audio and visual signalization (Pre-flash) causes that during the set time in parameter „2“, before the standard operation of gate, signalization starts functioning (flash and sound = warning light). When using function „Pre-flash“ and „Dead man“ it is necessary to permanently hold pressed button in required direction of gate movement and wait until the end of set time of pre-flashing before the gate starts moving into the required position.

IF SAFETY DEVICES (FUSES) IN CONTROL BOX ARE BLOWN, IT IS POSSIBLE TO TURN THEM ON ONLY ONCE – IF THEY ARE BLOWN ONCE MORE, IT IS NOT PERMITTED TO TURN THEM ON AGAIN

IF THE PROCEDURE STATED IN THE TECHNICAL DOCUMENTATION IS NOT RESPECTED, IT MAY LEAD TO THE LOSS OF WARRANTY

IN THE EVENT OF MALFUNCTION, FIRST IT IS NECESSARY TO DETECT POSSIBLE CAUSE OF THE MALFUNCTION AND REPAIR IT. AFTER THE MALFUNCTION IS REPAIRED, IT IS POSSIBLE TO TURN ON THE BLOWN FUSE AGAIN

IT IS FORBIDDEN TO MANIPULATE WITH CIRCUITS OF THE CONTROL BOX AND CHANGE THEIR CONNECTIONS. IN THE EVENT OF FAILURE TO COMPLY WITH THIS CONDITION, IT IS NOT POSSIBLE TO APPLY WARRANTY ON THE CONTROL BOX

CONTROL BOX CANNOT BE OPENED BY A PERSON WITHOUT APPROPRIATE TRAINING AND QUALIFICATION ACCORDING TO THE DECREE No. 50/1978, §6

Operating temperature of control box FSTronic DES-FS is from +10°C to +35°C. If the temperature of environment drops below +10°C or gets over +35°C the control box cannot be in operation! When temperature gets over +25°C or below +15°C, the battery life is reduced.

In exceptional cases control box FSTronic DES-FS can be operated at lower temperatures max. to -5°C, but the connection of input power supply has to be permanently provided to secure minimum heating of control circuits.

5. Description of control and terminal blocks

5.1 FUNC

Terminal block of function FUNC is used for activation of additional functions.

A-B - connected = DES operation

A-B - unconnected = NES operation

C, D, E, F, - free

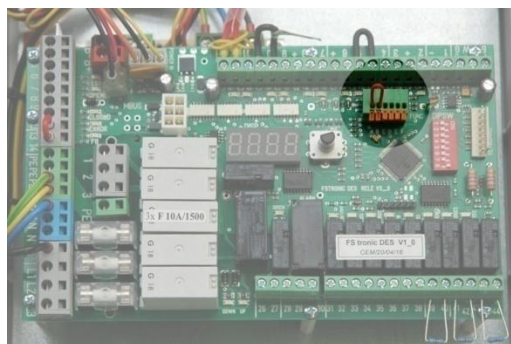

5.2 DIP switch

5.2.1 Description of DIP switch functions

DIP1 – activates signalization of lower safety sensor on LED indicator on the keyboard

DIP2 – activates signalisation of upper safety sensor on LED indicator on the keyboard

DIP3 – activates automatic closing after opening by pressing "open" button on the keyboard of control panel, "open" button has same function in case of activation as pull switch (i.e. after setting time in parameter „6”, gate is automatically closed)

DIP4 – activates shortening of automatic closing time when passing safety sensor. If the function is activated and safety sensors are installed, the gate immediately closes when passing the safety sensor and does not wait to the end of the set time in parameter „6”

DIP5 – selects if lock on the control panel only locks the panel buttons (open /close) or it also locks all external inputs on the terminal block (e.g. remote control...)

DIP6 – selects response mode to collision with an obstacle during closing. It is possible to select either 1) that the gate only moves back and then stops or 2) that after collision the gate fully opens and after the end of set time in parameter „5” it tries to close again (number of attempts for closing is set by parameter „4”)

DIP7 – communication option 19200 Bd / 9600 Bd. It is possible to select the communication frequency for motors GfA with encoder DES4 or motors MFZ with encoder AWG Kostal.

DIP8 – activates signalization of safety edge OSE – in case safety edge OSE is not connected, it is necessary to cancel its signalization on the panel. If OSE is connected, then we have to activate its function.

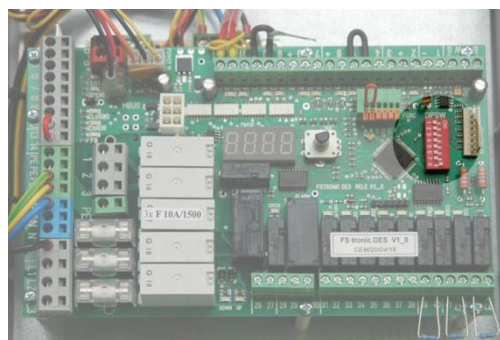

5.2.2. Description of setting functions on DIP SWITCH

POSITION	OFF	ON
1 Signalisation lower safety	ON	OFF
2 Signalisation upper safety	ON	OFF
3 "open" button – activate automatic close	OFF	ON
4 shortening of closing when passing safe. sensor	OFF	ON
5 locking of external inputs impulse+pull	OFF	ON
6 detection of obstacle during automatic closing	Open partly	Open fully
7 communication protocol	GfA/DES4	MFZ/AWG Kostal
8 activation of OSE	OFF	ON

5.3 Description of functions on display device

5.3.1. Control of menu on display

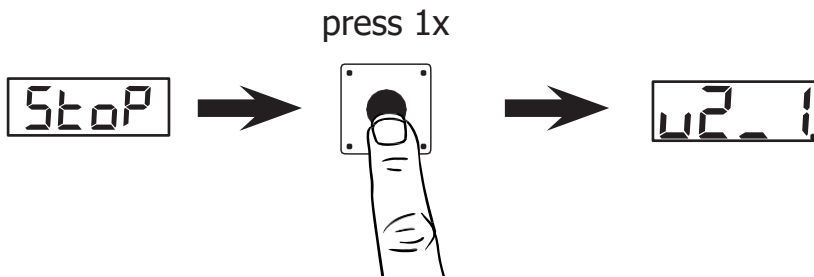

1x press shows actual version of program.

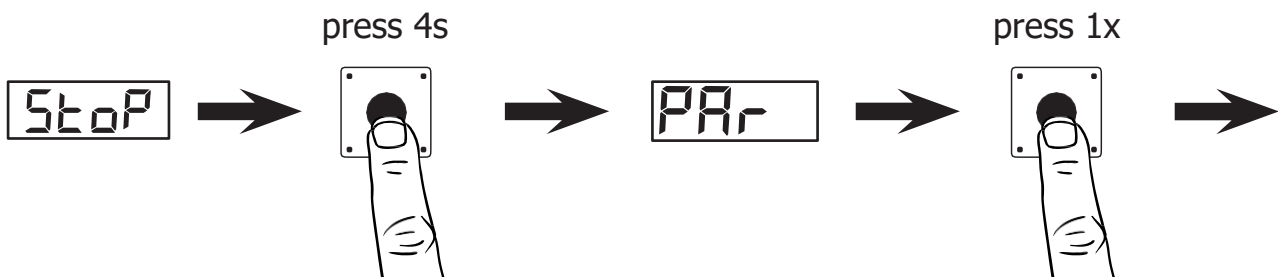



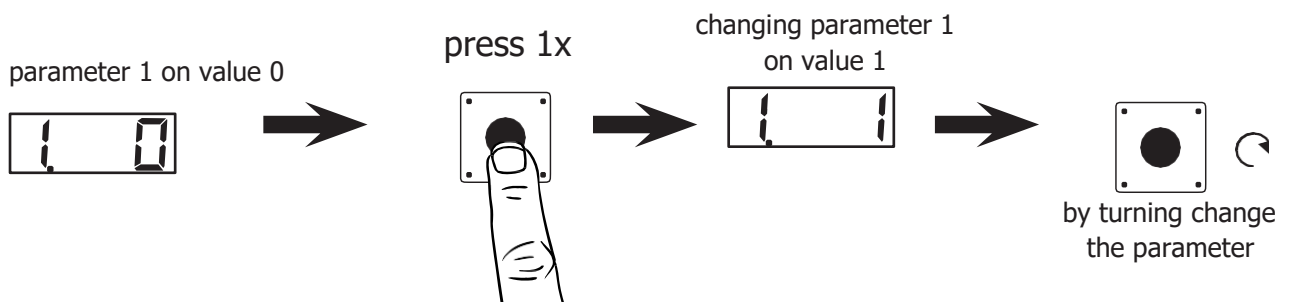







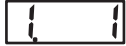
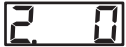

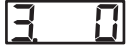
Description of setting of optional parameters on display device. To enter the setup we have to hold knob button and after 4 seconds display shows „Par”.



After displaying „Par” press knob button to display the individual parameters and their set value.

By turning the knob button you can display individual parameters and after pressing the knob button you can start to change the set values of the particular parameter – the value flashes. The parameter value can be changed by turning the knob button and after reaching the required value, it can be saved by pressing the knob button. If we do not want to change the parameter value, then we have to turn by the knob until the display shows „ESC” and then by pressing the knob button we move forward.

5.3.1. Parameters and their values:

- | | | | | | | | | | | | | | |
|---|--|---------------------|-------------------------|--|------------------|--|----------------------------|--|------------------|--|------------------|---|--|
| <p>1. Parameter - Audio & visual signalization functionality
 - warning light (output X2:26, X2:27)</p> <table border="0"> <tr> <td style="padding-right: 20px;"><u>during movement</u></td> <td><u>during alarm</u></td> </tr> <tr> <td>• 0 = active with delay</td> <td>active with delay, during alarm duration</td> </tr> <tr> <td>• 1 = not active</td> <td>active with delay, during alarm duration</td> </tr> <tr> <td>• 2 = active without delay</td> <td>active without delay, only during movement</td> </tr> <tr> <td>• 3 = not active</td> <td>active without delay, only during movement</td> </tr> <tr> <td>• 4 = not active</td> <td>active with delay, only during movement</td> </tr> </table> <p>Default = 0</p> | <u>during movement</u> | <u>during alarm</u> | • 0 = active with delay | active with delay, during alarm duration | • 1 = not active | active with delay, during alarm duration | • 2 = active without delay | active without delay, only during movement | • 3 = not active | active without delay, only during movement | • 4 = not active | active with delay, only during movement | 
 |
| <u>during movement</u> | <u>during alarm</u> | | | | | | | | | | | | |
| • 0 = active with delay | active with delay, during alarm duration | | | | | | | | | | | | |
| • 1 = not active | active with delay, during alarm duration | | | | | | | | | | | | |
| • 2 = active without delay | active without delay, only during movement | | | | | | | | | | | | |
| • 3 = not active | active without delay, only during movement | | | | | | | | | | | | |
| • 4 = not active | active with delay, only during movement | | | | | | | | | | | | |
| <p>2. Parameter – Time of pre-flash (delay to move) – in alarm
 Range of values: 0–999 seconds,
 Note: In case of setting time delay follow rules in standard EN 14637.
 Default = 0</p> | 
 | | | | | | | | | | | | |
| <p>3. Parameter – Time of pre-flash (delay to move) - normal operation
 Range of values: 0–999 seconds,
 Note: (when setting parameter „1“ “warning light” on value 1, there is running only the time of pre-flash, warning light is not active)
 Default = 0</p> | 
 | | | | | | | | | | | | |
| <p>4. Parameter – number of attempts to close
 Range of values:
 • 0-10 attempts
 • „-“ = endless number of attempts
 Note: (according to the setting DIP6 gate moves back or fully opens)
 Default = 0</p> | 
 | | | | | | | | | | | | |
| <p>5. Parameter – delay of closing attempts
 Range of values: 1–50 seconds
 Default = 10</p> | 
 | | | | | | | | | | | | |
| <p>6. Parameter – time of automatic closing
 Time after which the gate, opened by pull switch, starts to close.
 Range of values: 3–999 seconds
 Default = 10</p> | 
 | | | | | | | | | | | | |
| <p>7. Parameter – duration of movement back
 Motion back after collision with obstacle.
 Range of values: 1–10 seconds
 Default = 3</p> | 
 | | | | | | | | | | | | |

A Parameter – time of battery discharging

Time after which the gate, held on batteries, closes during power failure. Range of values:

- 0-30 minutes
- „-“ = depends on battery condition and load

Default = 10

When passed set time on display is displayed "A/L t"

When reached lowest battery capacity "-" on display is displayed "A/L b"

A 10
A 30

9 Parameter – Emergency Open hight

Setting of height for automatic open in alarm and activation of button Emergency Open (input X2:+, X2:9) Range of values:

- 30–100 % gate height
- „-“ = according to the setting of middle position

Note: When we have end switches NES it is possible to set only „-“ and the position follows the setting of middle position.

Default = 50%

9 50
9 100

A Parameter – Emergency Open time

Setting of time during which the gate waits in the set position after activation of button Emergency Open.

Range of values: 5–999 seconds

Default = 10

A 10
A 60

b Parameter – Permanent Open

Selection of input function of pull switch (input X2:+, X2:8)

- 0 – without permanent open – standard pull switch
- 1 – function “permanent open” is activated – if the input of pull switch is connected then it opens always when it is possible – closes only in alarm
- 2 – function permanent close

Default = 0

b 0
b 1

C Parameter – Return after alarm

What happens after cancelling the alarm:

- 0 = after cancelling the alarm, do nothing
- 1 = return to the state before alarm
- 2 = after alarm Open
- 3 = after alarm Close
- 4 = after alarm Reset will finish closing as the alarm will be active

Default = 0

C 0
C 3

d Parameter – Passing of closed position

Is used to pass the end position “closed” during alarm – contact of slats and labyrinths during closing in alarm

Range of values: 0–100 % from 6 % gate height.

Default = 0

d 0
d 100

E Parameter – time of Smoke alarm

E 10

Time in which the gate remains in alarm „Smoke” i.e. in position partly opened before closing again:

E 360

- 5–999 seconds
- „-” = time unlimited

Default = 10

F Parameter – duration of opening time in case of Smoke alarm activation

F 50

- 0–100% gate height
- „-” = according to the setting of middle position

F 70

Note: When we have end switches NES it is possible to set only „-” and position follows the setting of middle position.

Default = 50 %

H Parameter – do not monitor OSE / Ledge 8K2

H 1 H 100

The height from which the bottom edge of OSE is not monitored to prevent the unwanted opening before the contact with floor.

Range of values: 1–100 % from 10 promiles of gate height

Default = 30 %

L Parameter – correction of the end position “opened”

L 0

Range of values: -99 – +99 % from 1 % gate height

L 100

Default = 0

L Parameter – correction of the end position

L 0

“closed” Range of values: -99 – +99 % from 1 % gate height Default = 0

L 100

P Parameter – cyclic braking

P 0

(Suitable for tubular motors to increase safety of gravitational closing in alarm – functioning only if power supply or batteries are present)

P 30

- 0 - 30 = brake is cycle in impulses 0,12seconds long for 1 to 3 seconds
- „-” = brake is not pulsing

Default = „-”

If we choose setting of parameter “P” and proceed to its setting by pressing the knob button, it is possible after pressing the button CLOSE on keyboard, to proceed to the cycling of braking according to the currently set parameter. We can stop the cycling by pressing button STOP on the keyboard, during the cycling there is possibility to open by button OPEN on the keyboard, safety devices are active.



Parameter – cross optocell



Possible to set functionality of safety sensor (input X2:+,X2:2) for cross connection. Opportunity to use two optocells with cross safety beams under door leave. During closing gate will be functionality of safety sensor deactivated when reached position set by LS1 so moving door leaf will not activate the sensor. Necessary to set right position LS1. When this parameter set on value 1 then safety sensor between LS1 and bottom position is not active. (Typical application for conveyors)

Range of values:

- 0 = normal
- 1 = cross optocell

Default = 0



Parameter - service period (cycles)



service period 1 - 50 cycles, steps in 1000 cycles

Default = 3 (3000 cycles)



Parameter - conveyor confirmation



type of reaction when activated input "SMOKE" (X2:43 and X2:44)

0 = standard function "SMOKE"

1 = conveyor confirmation - in case of alarm and running time delay can be gate closed immediately when activated this input. When conveyor is clear gate can close quicker.

Default = 0



Parameter - initial alarm braking time



Allows you to select the length of the stop time in case of the FIRST activation of the safety device during closing in alarm.

Range of values: 1–999 second/s

Default = 10



Parameter - another alarm braking time



Allows you to select the length of the stop time in case of the SECOND and EVERY OTHER activation of the safety device during closing in alarm.

Range of values: 1–999 second/s

Default = 10



Parameter - type of input EPS - fire contact (X2:10, X2:+)

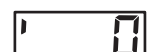

0 = NC input normally closed

1 = NO input normally opened

Default = 0



Type of relay output 400/230V power (X2:31, X2:32)



0 = power on - closed, power off - opened

1 = power on - opened, power off - closed

Default = 0



Type of relay output AKU (X2:31, X2:33)



0 = AKU ok - closed, AKU fault - opened

1 = AKU ok - opened, AKU fault - closed

Default = 0

Lr3	Type of relay output ERROR (X2:31, X2:34) 0 = ERROR - closed, no ERROR – opened 1 = ERROR - opened, no ERROR – closed Default = 0	Lr30
Lr4	Type of relay output FB safety brake (X2:31, X2:35) 0 = FB closed - closed, FB opened - opened 1 = FB closed - opened, FB opened - closed Default = 0	Lr40
Lr5	Type of relay output LS1 middle position (X2:31, X2:36) DES 0 = above LS1 - closed, under LS1 - opened 1 = above LS1 - opened, under LS1 - closed NES 0 = at LS1 - closed, out of LS1 - opened 1 = at LS1 - opened, out of LS1 – closed Default = 0	Lr50
Lr6	Type of relay output open position (X2:31, X2:37) 0 = at position - closed, under position - opened 1 = at position - opened, under position - closed Default = 0	Lr60
Lr7	Type of relay output closed position (X2:31, X2:38) 0 = at position - closed, above position – opened 1 = at position - opened, above position - closed Default = 0	Lr70
S-E	Servis end - settings of reaction in case of passing set value in parameter service period (time or cycles) 0 = after passing value - flashing diodes 1 = after passing value - flashing diodes + totman 2 = after passing value - flashing diodes + totman + by pressing stop for 3 seconds prolonged period for 500 cycles. Default = 0	S-E0
SE	Service period (time) Setting amount of months. Range of values: 3-60 months Default = 12 months (year)	SE.12
DEF	Reset to default parameters By choosing "YES" will set all parameters to default values	YES ESC

6. Counter of cycles on the control panel

Control box FSTronic has built-in internal memory, from which it is possible to display the state of performed cycles of gate. Counter supplied after installation is in reset mode. After change of some components (e.g. motor) or after the complete overhaul of mechanical device of gate, it is possible to reset the counter values – this operation can be done only by a trained service technician, who is authorized to do the operation (it is necessary to record the operation into service book of the gate).

6.1 Displaying counter values

If the gate is in Stop state, it is possible by turning the knob button to display individual cycle values one by one:

Operating counter – from putting into operation

P ⁻ XX = operating counter XX -- --
 P - XX = operating counter -- XX --
 P _ XX = operating counter -- -- XX

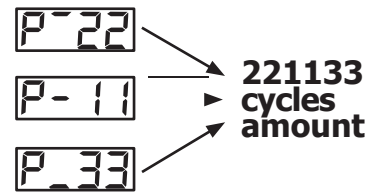

Alarms counter - from last service

A ⁻ XX = service counter XX -- --
 A - XX = service counter -- XX --
 A _ XX = service counter -- -- XX

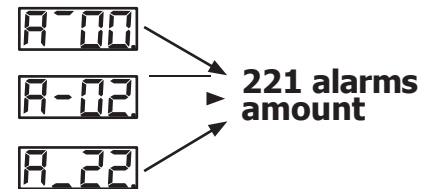

Service counter cycles – from last service

S ⁻ XX = service counter XX -- --
 S - XX = service counter -- XX --
 S _ XX = service counter -- -- XX

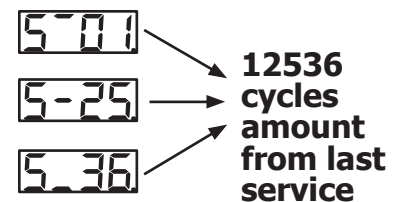

Service counter time – from last service

t ⁻ XX = service counter XX -- --
 t - XX = service counter -- XX --
 t _ XX = service counter -- -- XX

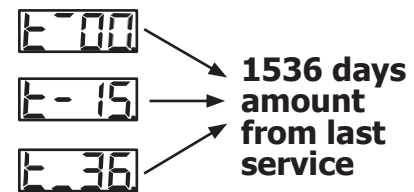

! Note: Reset can be done only by trained service. **!**

How to reset: Press button up + down at once for 10 seconds. All diodes will shortly flash - signal for successful reset done.

6.2 Indication of the end of service intervals

Control box FSTronic is equipped with internal memory, which displays end of pre-set service interval by simultaneous and synchronized flashing of all diodes. Standard interval is pre-set on 3000 cycles (see setting of parameter \overline{E}) or 1 year (see setting of parameter \overline{SE}) from the last service (or putting into operation). In case of the signalization of the end of service interval it is necessary to contact service organization to do the service inspection. After the inspection of gate, control is set into the standard operation mode again. Even when signalization of the end of service interval is activated, all control functions stay unchanged – only displaying of alarms is affected by synchronized flashing of service interval

7.Value report on the functional display



Little LED in bottom right corner quickly flashes (nearly continuously ON) according to the communication with encoder in the motor. If flashes with interruptions than communication is incorrect – in this case check connection of communication cable or setting DIP7.

If sign STOP quickly flashes then is disconnected input X2:+, X2:5 or is pressed button STOP on the keyboard - this blocks movement of the gate.

If gate is in STOP mode (no movement) it is possible by turning knob display another information values as described in 6.1 and following:























Indication from end switch DES 2B hexa – (e.g. 6Hr2).



Indication of voltage on low voltage circuit. In case of connected batteries indicated voltage on battery. A 24.2 means battery voltage 24.2 V

7.1 On display we can see these basic values

- 1)  After reset.
- 2)  After reset it initializes.
- 3)  Stop. If flashes see point 7.
- 4)  Opening.
- 5)  Closing.
- 6)  „Time open“ calibration of opening time – only during the setting.

- 7)  Opening "deadman".
- 8)  Closing "deadman".
- 9)  Waiting for automatic closing 88 = seconds.
- 10)  In position 1 flashing „A/L“ i.e. alarm.
 In position 2 it displays:
 - „F“ - alarm from EPS input X2:+, X2:10
 - „b“ if the time ended (discharged) or the battery voltage dropped and power supply is not present
 - or nothing
In position 3 it displays:
 - „d“ - detector alarm input X2:41-X2:42
 - or nothing
In position 4 it displays:
 - „S“ - SMOKE alarm input X2:43-X2:44
 - or nothing
- 11)  Movement back upwards – reversal after collision with an obstacle.
- 12)  Waiting for closing after movement back XX = seconds.
- 13)  In SMOKE alarm it goes to position SMOKE.
- 14)  Time SMOKE until alarm (e.g. 12 seconds).
- 15)  Return from alarm into the position before alarm - opening – only DES setting of parameter „C „ in 1
- 16)  Return from alarm into position position before alarm – closing - only DES setting of parameter „C „ in 1
- 17)  movement back upwards after passing the lower end position – „repeated movement back“
- 18)  In alarm opens to position set for emergency open.
- 19)  Countdown for time to close in emergency open.

7.2 Errors report on functional display

EdEr

Error DES failure of communication.

EtEr

It did not reach the position in time, went to "stop", can be reset by new impulse to movement. If this alarm is repeated it is necessary to recalibrate time see 3.1.5. In specific cases with special motors where is longer acceleration under the load can be detected this fold then set parameter "U" and both "y" on maximum values and then recalibrate the time. After recalibration can be parameters "U" and both "y" reduced to previous values.

FFEr

Error of movement direction, went to „stop“, can be reset by new impulse to movement from the keyboard of the control box, external inputs are blocked. Before correction of the error, the keyboard of the control box must be locked and unlocked, otherwise it does not react. (3.1.1.–3.1.5.).

EEEr

Error of EEPROM – internal memory for saving parameters, end switches and counter. If the data do not correspond, they can be reset by restart.

ECEr

Error of control amount position DES. Indicated when deleted end positions or by internal error. In case of this fold reset end positions (3.1.1.–3.1.5.).

EPEr

Error of limit switches activation of safety switch, error of position. Reset positions (3.1.)

ESEr

Error of time calibration. Set the calibration time (3.1.5.).

brEr

Error of motor brake indicated during motor movement break is not released. Check the break connection and parameter "r".

FbEr

Activation of safety break (input X1:13,X1:14)

8 Connectors

8.1 Connectors on DPS - (terminal block X1)

L1, L2, L3, N, PE	power supply 3x400/230V TN-S
1, 2, 3, PE	drive motor
4	brake 0V
5	common for end switches NES
6	end switch middle position 1 (emergency) NO NES
7	end switch opened NC NES
8	brake +24V
9	end switch switch "closed" NC NES
10	safety end switch NC NES
13, 14	safety brake NC

Terminals 5,6,7,9,10 – in DES mode have to remain free – unconnected!

8.2 External - terminals on DPS in the contr. box (terminal block X2)

a) Input side (upper part of the terminal block X2)

Terminals marked „+“ are common (+24 V), inputs are activated by connecting to „+“







OSE – optical safety edge

+ (B)	+12V	(brown receiver and transmitter)
- (W)	0V	(white receiver and transmitter)
O(G)	output	(green receiver and transmitter)

1	+24 V	to power safety sensors and external devices
-	0 V	to power safety sensors and external devices
2		“LOWER INFRA” - NC contact of safety sensor for closing
+		+24 V
3		“UPPER INFRA” - NC contact of safety sensor for opening – against closing. It also serves to connection of safety sensor of passage door – i.e. always during operation and disconnection of the contact, gate closes (without moving back)
+		+24 V
4		OPEN - NO contact
+		+24 V
5		STOP - NC contact. NOTE: Used only as input STOP, do not connect any functional blocking of the drive. Functional blocking connect only to input “upper infra”.
+		+24 V
6		CLOSE - NO contact
+		+24 V
7		IMPULSE - NO contact (step by step)
+		+24 V
8		PULL - NO contact (always opens and if the safety devices allow that the gate closes after the end of set time)
+		+24 V
9		„EMERGENCY OPEN - NO contact - after activation during alarm gate opens into position set by Par „9“, and after the end of set time Par „A“ it closes in alarm closing mode
+		+24 V
10		FAS (EPS) „fire contact“ – type of input according to setting Parameter <input type="checkbox"/> type of input EPS
+		+24 V
11		RESET - NO contact – resets the control box
+		+24 V
12		LOCK - NO contact on the panel – in case of detector alarm, it resets
+		+24 V

The remaining inputs are connected to the power terminal block X1.

b) output side (lower part of the terminal block X2)

- 26 warning light 0V
- 27 warning light +24V
- Maximum load of output warning light 24VDC/1A
- 28 alarm NO
- 29 alarm NC
- 30 alarm COM
- 31 relay COM (terminals X2:32 to X2:38)
- 32 without 230V – output according setting 
- 33 discharged battery - output according setting 
- 34 safety end switches - output according setting 
- 35 safety brake – output according setting 
- 36 middle position LS1 - output according setting 
- 37 opened – output according setting 
- 38 closed - output according setting 
- Maximum load of output relays X2:32 - X2:38 -max.60V DC/AC, 1A each, 5A total for all
- 39 contact strip 8k2 - 0V (to connect contact strip we use closed loop 8,2 kΩ between X2:39 and X2:40)
- 40 contact strip 8k2 - +24V (to connect contact strip we use closed loop 8,2 kΩ between X2:39 and X2:40)
- 41 smoke/heat detectors 0V (to connect detectors we use closed loop 4,7 kΩ between X2:41 and X2:42)
- 42 smoke/heat detectors +24V (to connect detectors we use closed loop 4,7 kΩ between X2:41 and X2:42).
- 43 Function of „Smoke“ alarm – when detector is activated, gate opens into the set position and after the end of set time it closes.
detectors used for function „Smoke“ alarm 0V (to connect detectors we use closed loop 4,7 kΩ between X2:43 and X2:44)
- 44 detectors used for function „Smoke“ alarm +24V (to connect detectors we use closed loop 4,7 kΩ between X2:43 and X2:44)

Input 43,44 can be used as alarm confirmation see Parameter:

Parameter - conveyor confirmation

9. Control panel

9.1 Key switch

- Keys switch on control panel in position 0 = buttons "Open" and "Close" not active, eventually not active also external inputs see setting DIP 5 point 5.2
- In case of activation of fire detectors - switch on and switch off = reset of alarm



9.2 Description of control panel



- ▲ **OPEN** = button open gate
- **STOP** = button stop, by continuous pressing for 10 seconds is activated reset of fire detectors
- ▼ **CLOSE** = button close gate

On control panel of FSTronic there is installed keyboard with buttons OPEN, STOP, CLOSE. On the keyboard there are also LED diodes, which display all current states of the control. This enables the gate operator to determine particular states and potential gate alarms.

9.3 Description of individual LED diodes:

-  If the diode is permanently ON, control is activated.
If the diode flashes (0,5s – 0,5s), gate is in motion.
If the diode flashes quickly (0,1s – 0,1s), running countdown for delay of movement.
If the diode is off, key switch is off - keyboard is not active.
-  Standardly, the diode is OFF and does not flash. If the diode flashes, the optical safety edge OSE was activated. If the OSE is not installed then the diode keeps flashing, this display can be deactivated by switching DIP 8 into position OFF.

-  Standardly, the diode is OFF and does not flash. If the diode flashes, the lower or upper safety sensor was activated. If the lower safety sensor is not installed then the diode keeps flashing, this display can be deactivated by switching DIP 1 into position ON. If the upper safety sensor is not installed then the diode keeps flashing, this display can be deactivated by switching DIP 2 into position ON.

If the diode does **1 short flash**, the lower safety sensor is activated.

If the diode does **2 short flashes**, the upper safety sensor is activated.

In case both safety sensors are activated at the same time, they are displayed one by one i.e. 1 flash – pause – 2 flashes.

-  Standardly the diode "!" is OFF and does not flash. If the diode flashes, one of the alarms is activated (see below).

In case of all LEDs flashing at once passed service interval. See point 6.2

9.4 Overview of alarms

- If the diode does **1 short flash**, the EPS (fire alarm system) is activated – fire alarm is activated by central fire signalization or by local detectors. If the local detectors are installed, to cancel the alarm it is necessary to switch the key switch ON and OFF on the control panel or press button STOP continuously for 10 seconds – which causes RESET of detector. If the alarm is activated by central fire signalization, the alarm is cancelled automatically – it is not necessary to do the RESET with key switch.
- If the diode does **2 short flashes**, power supply 1x230V or 3x400V has failed.
- If the diode does **3 short flashes**, it signals poor battery, voltage of battery cells dropped below 24,0V.
- If the diode does **4 short flashes**, safety end switches are activated – gate passed one of its standard end positions. Service intervention is necessary.
If the lower safety end switch was activated by gate closing down in alarm without batteries, it is possible to move the gate from that position using function „**repeated movements back**” – by switching the key switch OFF and ON there is activated an option of short movement upwards (3 times) by pressing button OPEN on the keyboard, this cycle can be repeated.

- If the diode does **5 short flashes**, safety brake is activated. Service intervention is necessary. In this case the button CLOSE is blocked and gate can be operated only in direction OPEN and in "Dead Man" mode. To unblock the safety brake, it is necessary to carefully open the gate about approx. 5cm – which should unblock the safety brake. Then it is necessary to deactivate microswitches on safety brake (see manual of supplied safety brake). This operation can be done only by an authorized person with appropriate training. In any case it is necessary to do the service of mechanical device of gate to determine cause of the safety brake activation.

In case that several alarms are activated at the same time, they are displayed one by one by appropriate number of flashes with a short pause between each displayed alarm (e.g. 2 short flashes – pause – 4 short flashes. i.e. power supply has failed and at the same time safety end switch has been activated).

In case of all LEDS flashing at once passed service interval. See point 6.

10. Regular service

10.1 Control box

Component	Control	Performed operation	Cycle
Terminal block	Loose screws Loose connectors	Tighten	1 year
Contactora, relay	Loose connections Visual control	Tighten Replacement after control	1 year

10.2 Battery – required user maintenance

It is related to the optional accessories – battery module.

Component	Control	Performed operation	Cycle
Battery modules FSTronic	Time of holding the gate in open position until the battery is discharged – for at least 30minutes. Warranty for battery of safety devices is one year.	Disconnection of main power supply or <u>Replecement of batteries for new!</u>	1 year

As an additional accessories of control box FSTronic DES-FS, it is possible to add battery module with hermetic PB batteries.

To secure their safe operation the following conditions apply:

Precondition for reaching full life of the hermetic PB batteries is their proper charging (life of common types of batteries is approx. 5 years during optimal operating temperature 15-20°C). Charging is provided with charging circuit of FSTronic if the control panel is connected to power supply. In case of power failure longer than 2 hours, disconnect batteries by connector disconnection to avoid battery discharging due to powering of control panel – it is necessary to insulate battery connector with plastic cover (see point 3 – putting

into operation). Under normal operating conditions, battery is hermetically sealed, no leak from safety plugs and battery can be operated in any position. To maintain function of the safety plugs (e.g. in case of charger failure) it is necessary to leave free space in front of the upper side containing safety plugs. Life of PB batteries can be also reduced if they are repeatedly fully discharged. If the battery is permanently fully discharged it may also cause its damage. New batteries are standardly supplied partially charged. Optimal storage temperature is 15-20°C. During storage the load has to be disconnected! Before storage, the battery has to be charged and during long-term storage (at the recommended temperature) it is necessary to recharge the battery at least every 9 months. If the storage temperature is higher it is recommended to recharge the batteries more often. Higher temperature significantly decreases the average life of PB batteries.

SAFETY INSTRUCTIONS FOR HERMETIC PB BATTERIES:

- It is important to maintain correct polarity – do not switch the poles, keep contacts clean.
- Use them only for electrical appliances, which they are intended for.
- Hermetic Pb batteries cannot be replaced by common car or motorcycle batteries.
- If the battery is getting overcharged during using the original charger, the charger is damaged. Immediately stop using the defective charger and hand the charger over to professional service for repair.
- **For charging the PB batteries it is not possible to use chargers for common car and motorcycle batteries or chargers for NiCd, NiMh or other types of batteries.**
- Protect the batteries against short-circuit, do not overload or heat the batteries, do not throw them into fire, do not open, deform or damage them.
- Hand the old batteries in to the collection place.

If the batteries are damaged by improper use or **by failure to follow principles mentioned above, the warranty cannot be applied!** To determine the cause of battery fault in order to claim warranty, the seller reserves the right to test the **conditions of the operation**. If improper conditions are found out, **the work connected with the control and measurement of the conditions will be charged.**

11. Circuit diagrams

- FSTronic DES-FS 3x400V - control board
- FSTronic DES-FS 3x400V - motor FS – end switches DES
- FSTronic DES-FS 3x400V - motor FS – end switches NES
- FSTronic DES-FS 1x230V – control board
- FSTronic DES-FS 1x230V - motor FS – end switches DES
- FSTronic DES-FS 1x230V - motor FS – end switches NES
- FSTronic DES-FS 1x230V – tubular motor – end switches NES
- FSTronic DES-FS – fire detectors
- FSTronic DES-FS - battery module
- FSTronic DES-FS – motor cable
- FSTronic DES-FS – connection OSE + door safety contact
- FSTronic DES-FS – light curtains

FSTronic DES-FS 3x400V Control board

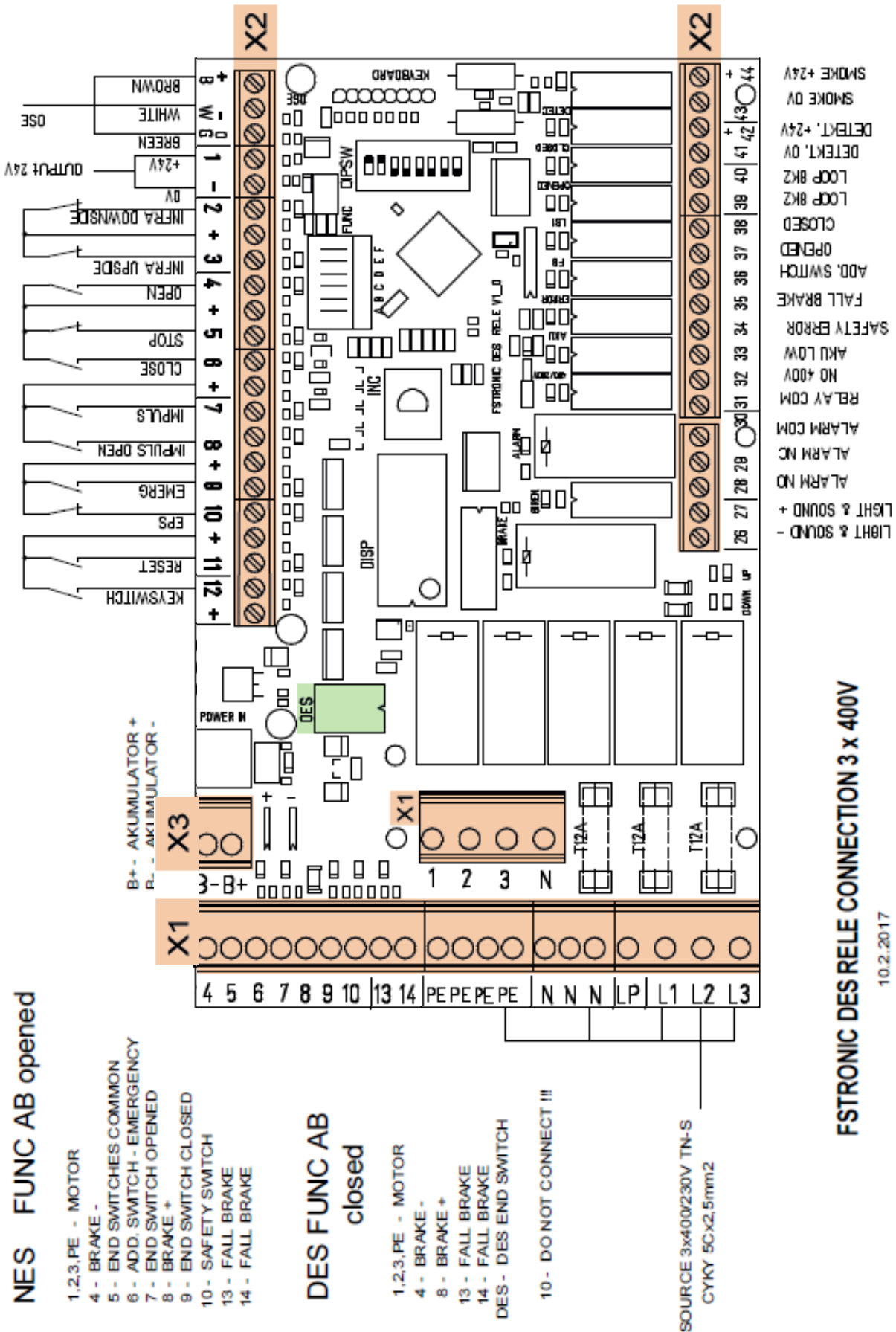

FSTRONIC DES RELE CONNECTION 3 x 400V

10.2.2017

SOURCE 3x400/230V TN-S
CYKY 5Cx2,5mm²

FSTronic DES-FS 3x400V

MOTOR FS – DIGITAL LIMIT SWITCHES DES

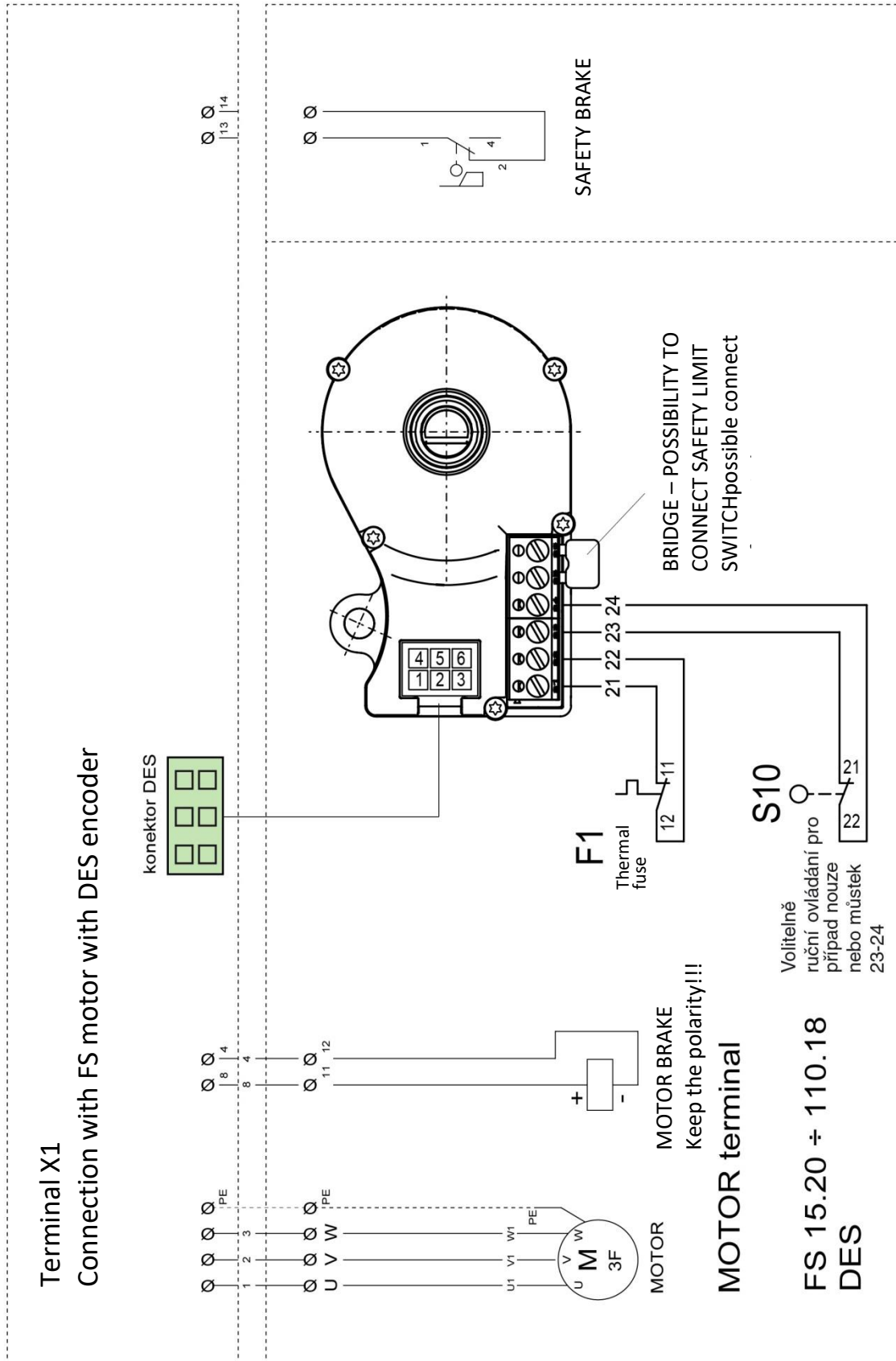

FSTronic DES-FS 3x400V

MOTOR FS – MECHANICAL LIMIT SWITCHES NES

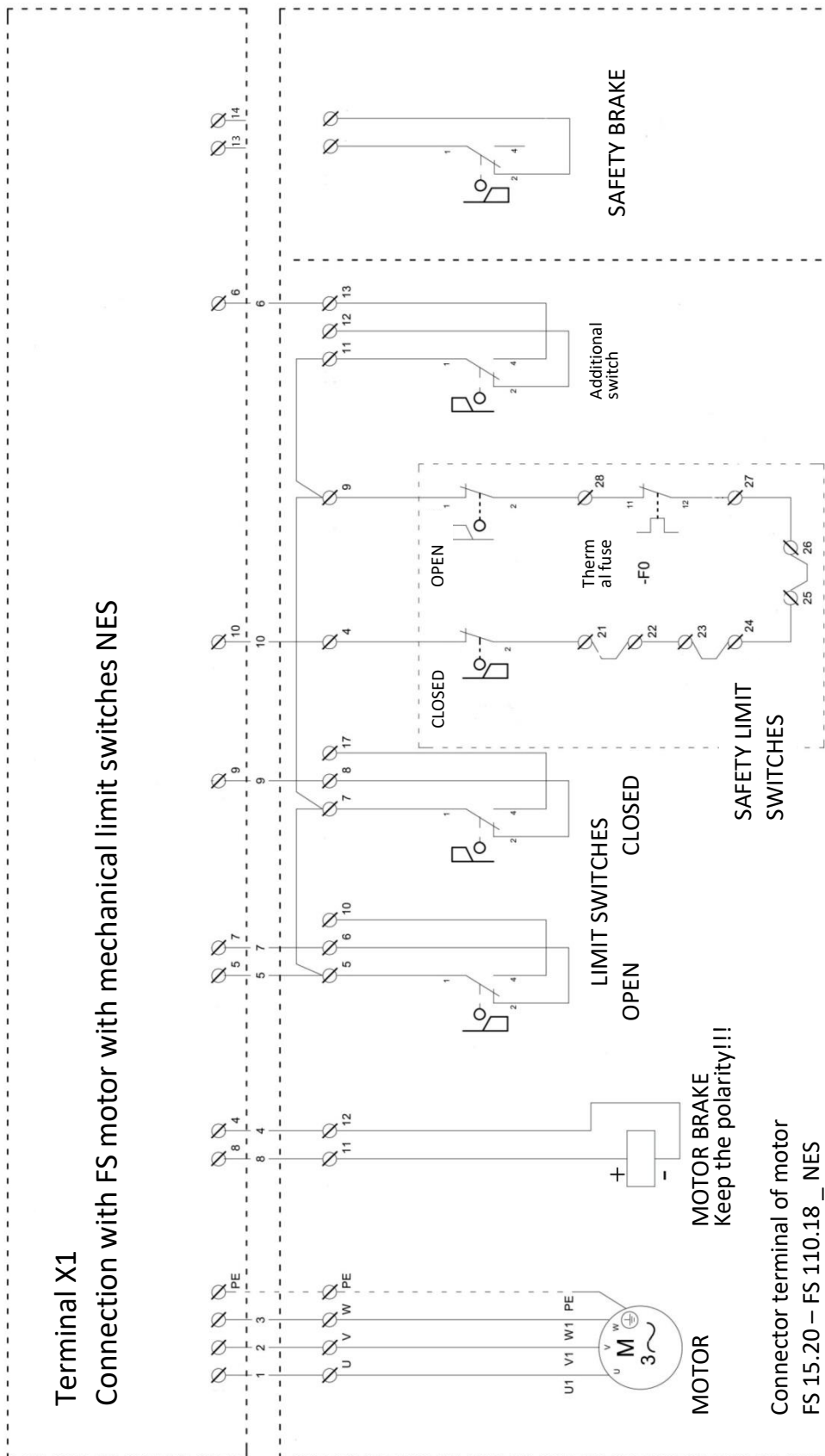

FSTronic DES-FS 1x230V

Control board

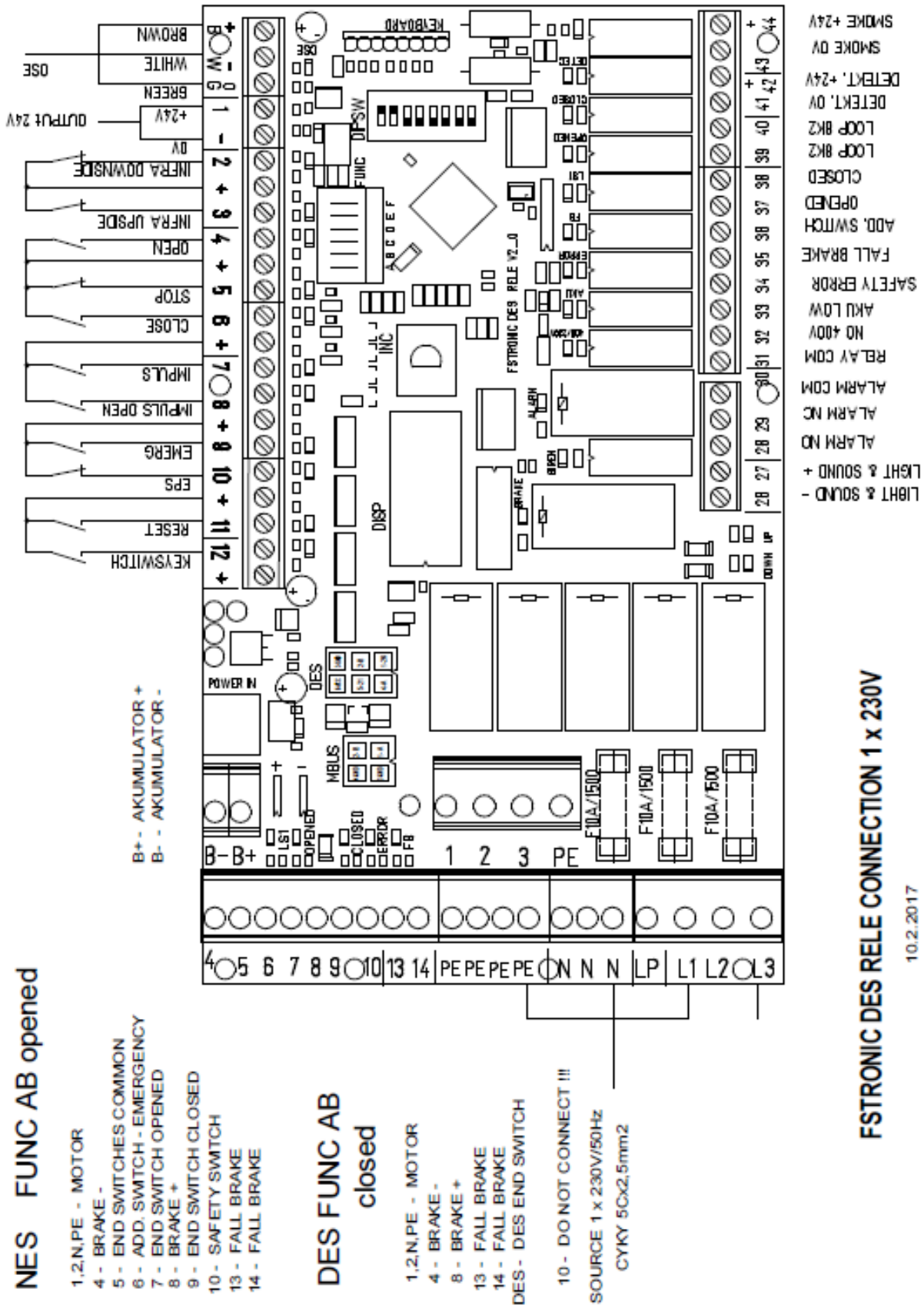

FSTRONIC DES RELE CONNECTION 1 x 230V

10.2.2017

FSTronic DES-FS 1x230V

MOTOR FS – END SWITCHES NES

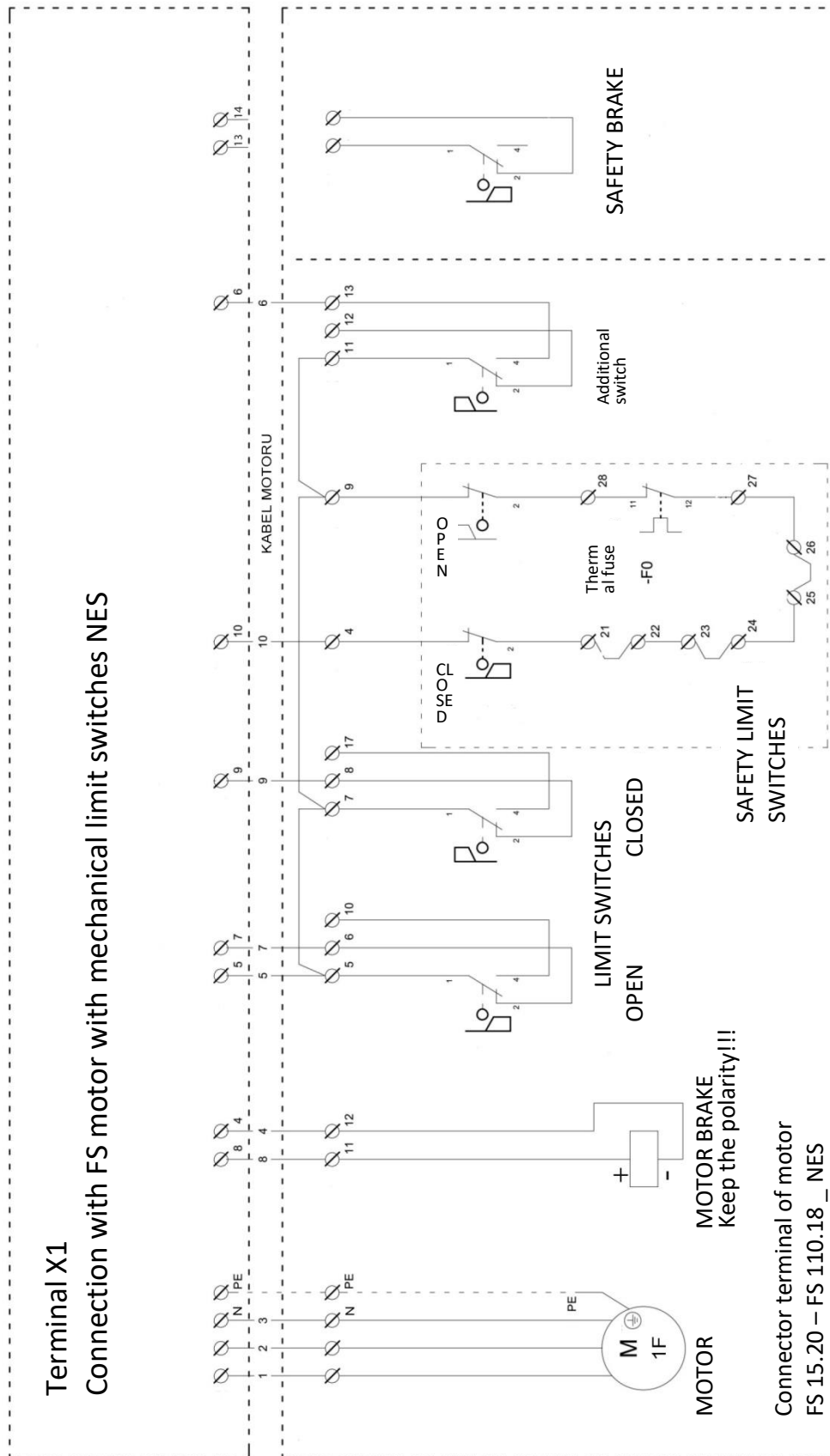

FSTronic DES-FS 1x230V

TUBULAR MOTOR - END SWITCHES NES

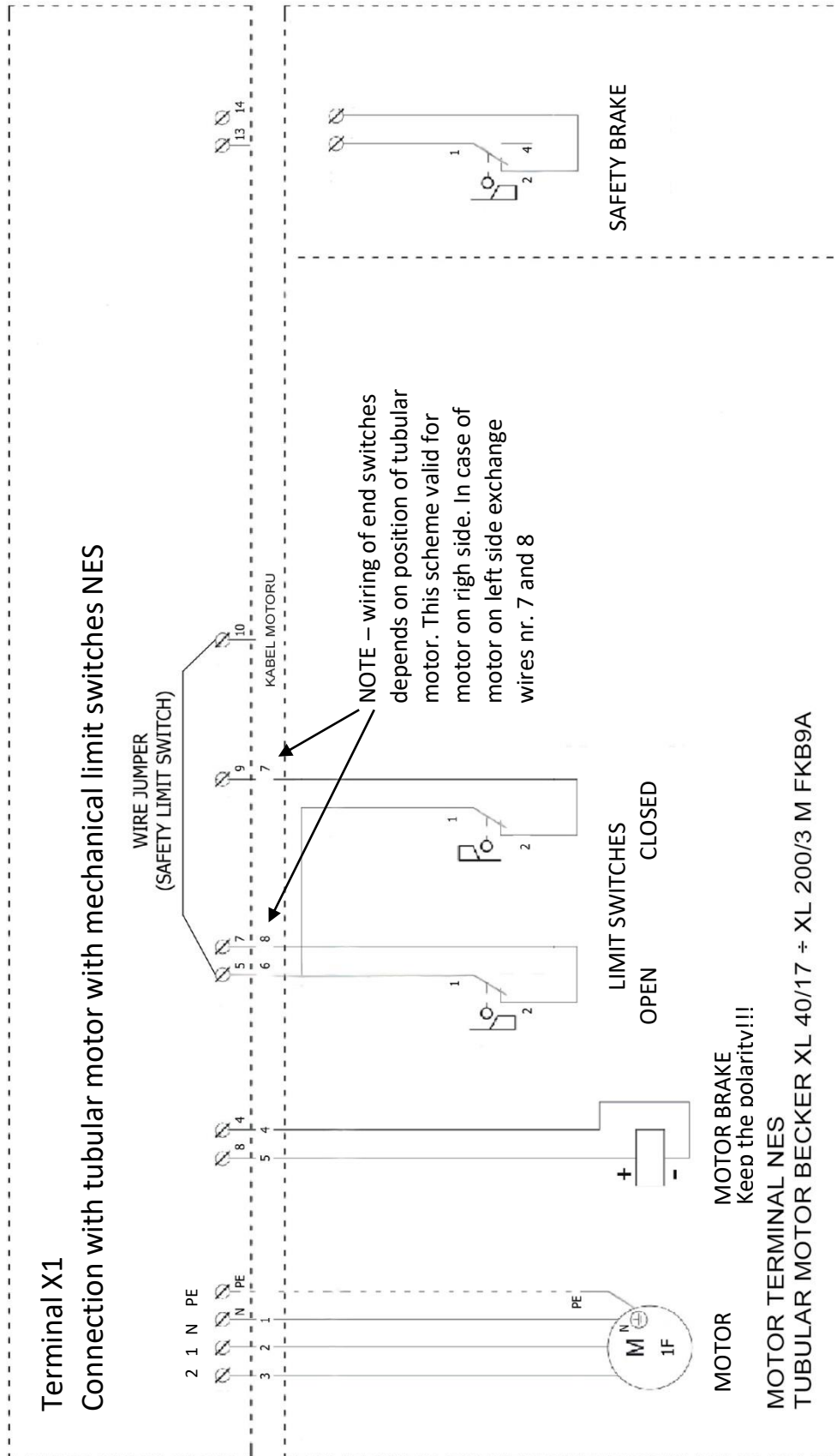

FSTronic DES-FS

FIRE DETECTORS

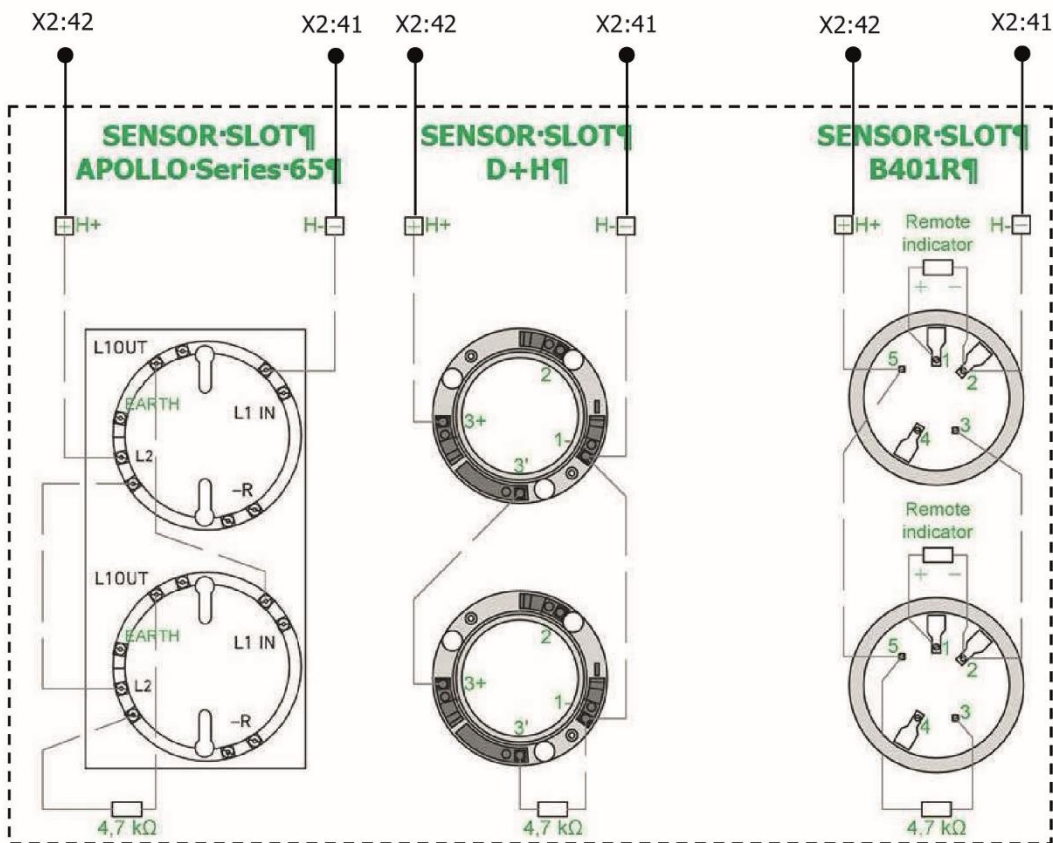
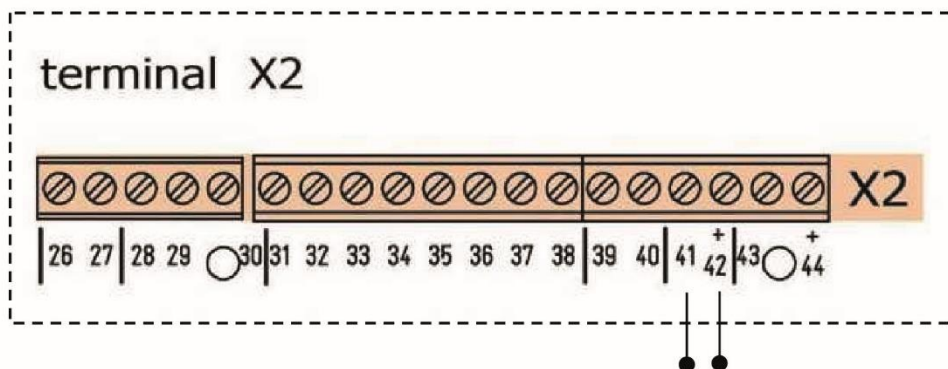

FSTronic DES-FS

BATTERY MODULE

Important note: if connected deeply discharged battery it can cause malfunction of control unit – all displays will be off as all current is redirected to the batteries to charge them. Control unit will start work properly automatically when batteries will be charged above 25,6V

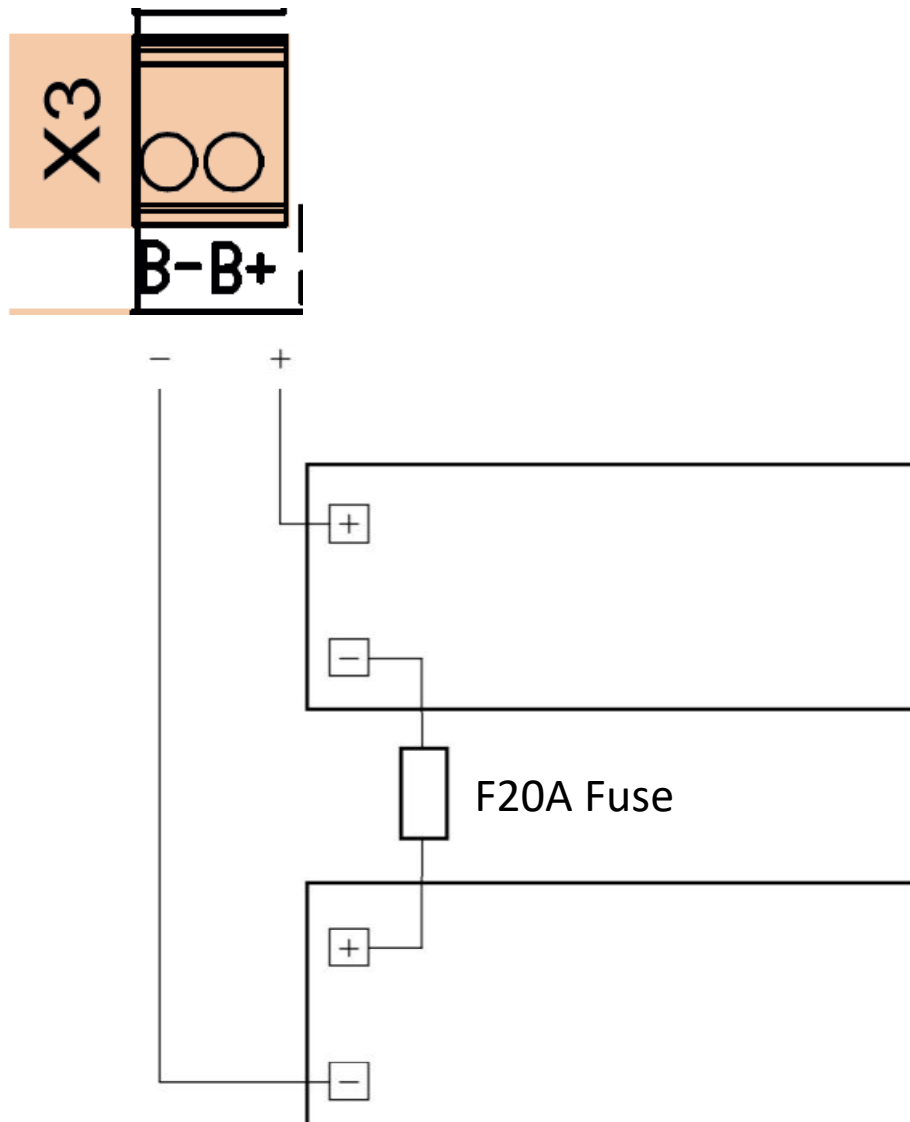

FSTronic DES-FS

MOTOR CABLE

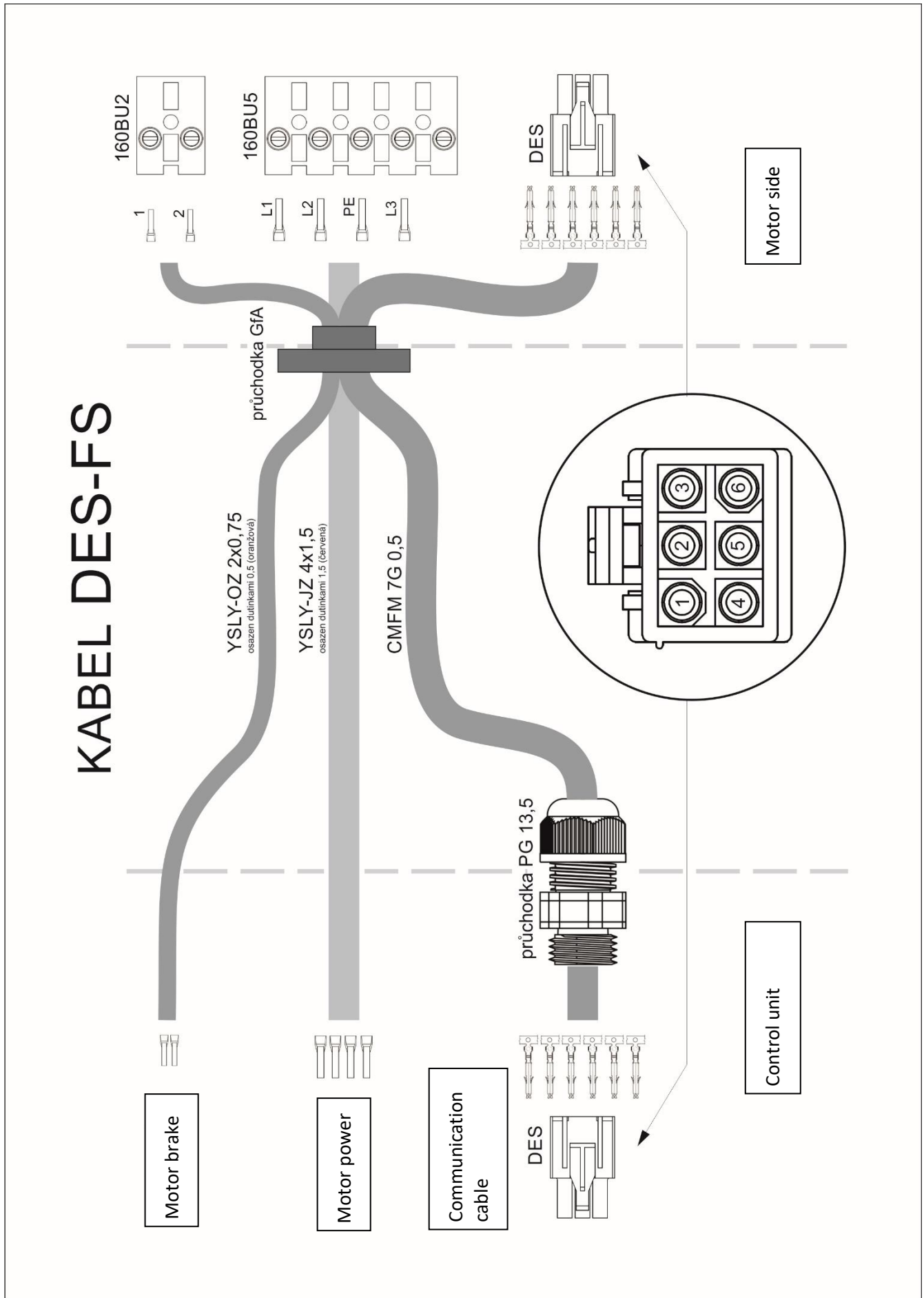

FSTronic DES-FS

CONNECTION OSE + DOOR SAFETY CONTACT

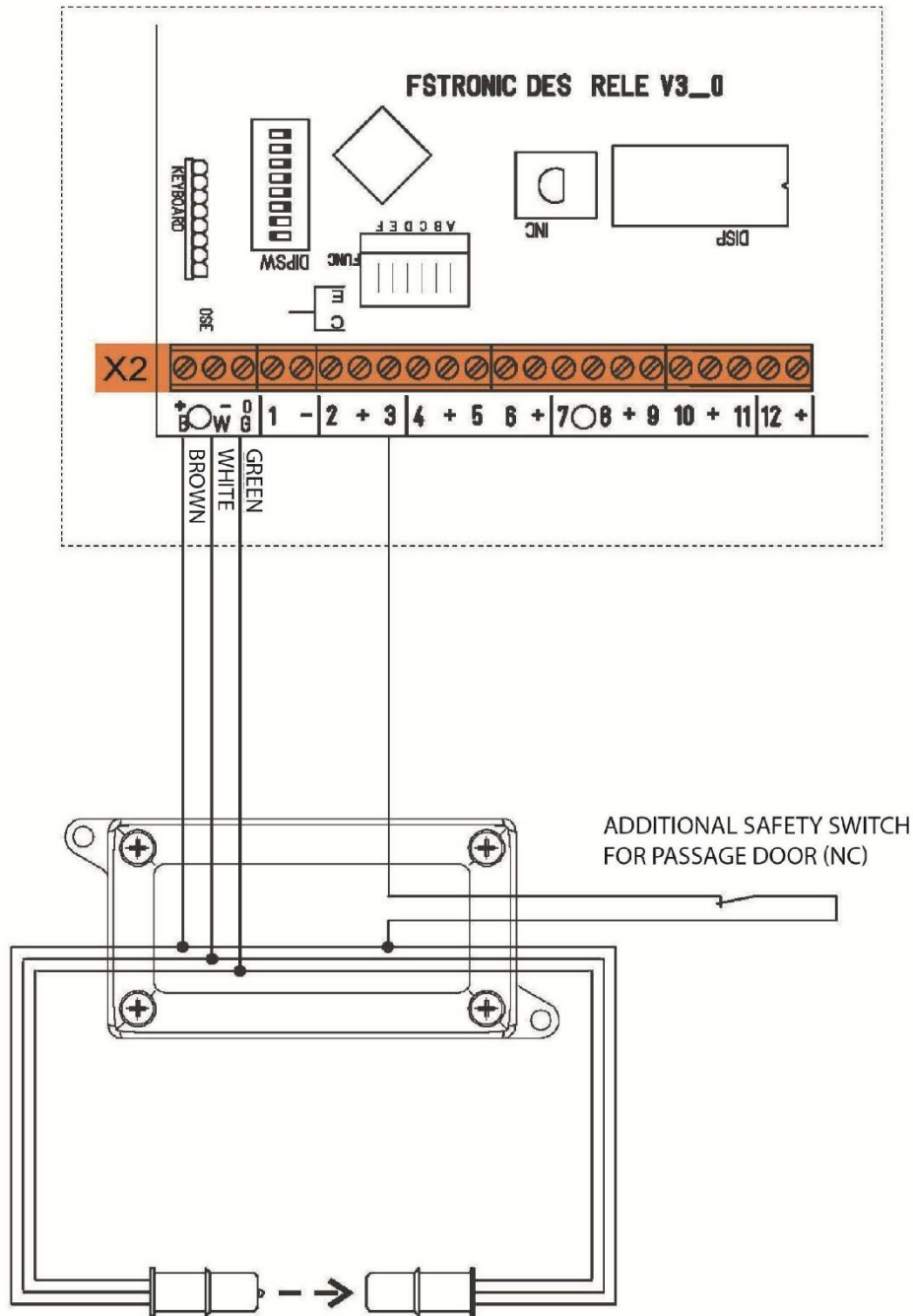

FSTronic DES-FS

Connection of different types of light curtains

Cegard Mini SY2000:

Cegards Mini SY2000

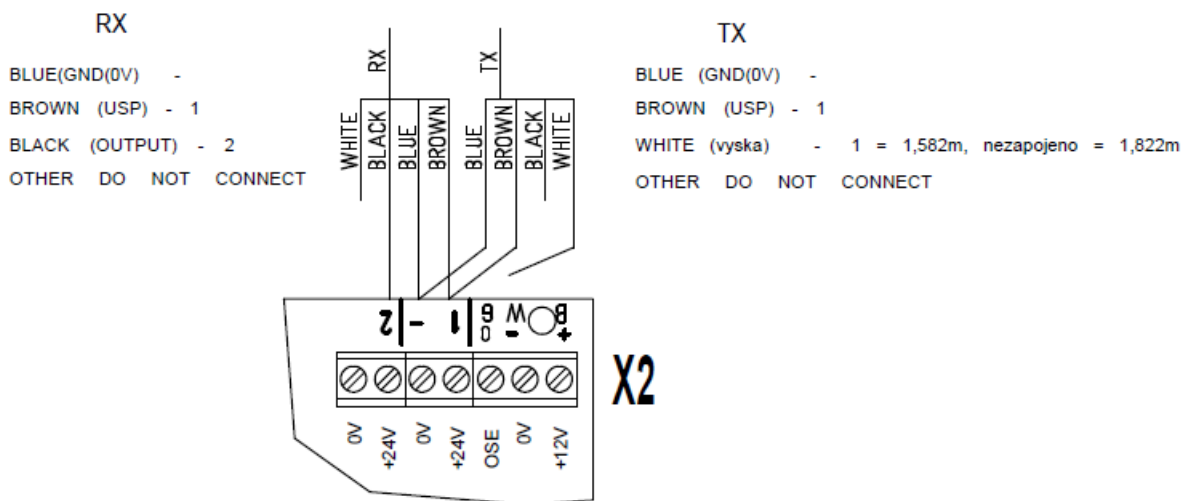

LIGI-07 OSE:

LIGI-07 OSE

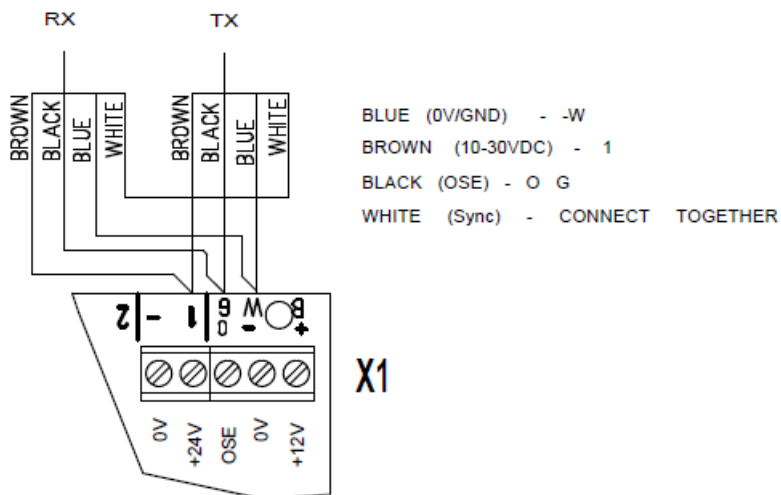

activate input OSE - DIP8 set to ON

GridScan MINI FSS:

GridScan/MINI FSS

GRS/Mini - aa - bbbb - cc, dd, e, f, gg, hh
e = F

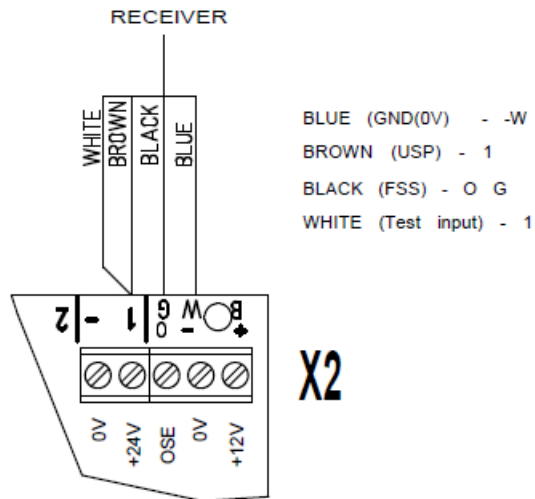

ACTIVATE INPUT OSE - DIP 8 set ON

GridScan MINI PNP/NPN:

GridScan/MINI PNP/NPN

GRS/Mini - aa - bbbb - cc, dd, e, f, gg, hh
e = N

