



FSTronic and FSTronic 24 controls for drives of sliding and sectional fire doors

List of documentation:

TECHNICAL REPORT

- 1. POWER SUPPLY**
- 2. CONFIGURATION**
- 3. INSTALLATION AND SETUP**
- 4. DESCRIPTION OF CONTROLS**
- 5. CONTROL PANEL**
- 6. REGULAR PREVENTIVE CHECKS**
- 7. CIRCUIT DIAGRAMS**
- 8. ES DECLARATION ON CONFORMITY**



1. Power Supply

Voltage system:	3 NPE, 50 Hz, 3 x 400/230 V, TN-S
Operating voltage:	24 V DC
Motor output voltage:	3 PE, 50 Hz, 400 V AC, TN-C
Brake voltage:	24 V DC

Protection against electrical accidents is provided in accordance with ČSN 33 2000-4-41 by automatic disconnection of the faulty section from the power source and by means of supplementary safety circuits.

2. Configuration

The FSTronic design controls the sliding door drive using an FS (fail-safe) motor manufactured by GfA and in the FSTronic 24 modification an FDF motor manufactured by MFZ for controlling a sliding door drive.

FSTronic – in combination with the FS motor it ensures gravitational closing of the door in case of an alarm.

FSTronic 24 – in combination with the FDF motor it ensures closing of the door with an auxiliary battery-powered DC motor in case of an alarm.

Both control panels, FSTronic and FSTronic 24, have identical outer dimensions and all the same control features. The only difference is in the internal connection and components.

Power to the control circuits is backed up by batteries, thereby enabling the door to remain in open position even during a power outage. The battery also provides power to all supplemental safety features during gravitational (FS motor) or electrical (FDF motor) closing after a power outage. (Closing by gravitational/electrical auxiliary motor will occur if the power supply from the network is not reestablished and the voltage on the battery drops below the threshold of 21.0 V. Closing by gravitational/electrical auxiliary motor will also occur if the battery is depleted below 18.0 V, even if network power is supplied.)

Instrumentation is situated on the panel in the FSTronic switchboard, and an instrument wiring diagram is included in the design documentation. The dimensions of the switchboard are 400 x 300 x 130 mm (W x H x D). The inputs and outputs of power and control circuits are led through PG bushings at the bottom of the switchboard.

3. Installation and setup

The drive is preset and after connecting the external control elements (controllers and limit switches) it requires only a function check. Pay particular attention to the functionality of the limit switches. Improper mechanical or electrical setup of these switches can damage the door's mechanics. The entire mechanical part of the door installation must be completed during the first installation so that the door will not be mechanically damaged when the motor is turned on. Before first activation, connect only the:

- power cable;
- motor cable;
- EPS (X2:⊥ and X:10) connectors, NC contact (with a disconnected contact, the door still closes gravitationally [electrically from batteries]); and
- batteries to the controls. The battery as supplied is disconnected (one battery connector is disconnected); the connector is insulated by a cover which must be removed. Connecting the batteries is absolutely necessary for providing power to the auxiliary DC motor in the FSTronic 24 version. If an alarm is sounded without the batteries being connected, the FSTronic 24 variant will overload the 24 V source and the unit will reset – the closing alarm will not function. To maintain proper fire-protection functioning, the batteries must be



connected and sufficiently charged so they are able to provide power to the auxiliary DC motor.

Do not connect any external controllers or other devices before the limit switches are set up. Automatic operation may commence without restriction if the limit switches are not set up.

After the setup of limit positions is tested, other external elements may be connected. The FSTronic control panel includes a switch plate with standard “Open” and “Close” buttons. These can be used to open the door in the “dead man” mode. For automatic operation (one-press start) upwards it is necessary to connect the connectors X2:1 and X2:3 by a jumper or electronic safety device. In case of a door surface which a person can hold onto or through which an object can be put, it is absolutely necessary for automatic operation to be accompanied by the upper infrared detection safety feature.

Downward automatic movement is activated by connecting the lower infrared detector photodetectors to the X2:1 and X2:2 connectors (lower infrared detector) or the optical sensing strip (OSE) to connectors X2:G, X2:W and X2:B. If the photodetector disconnects (when it is OSE equipped) as the door is closing, then the door will move back and stop.

If the lower infrared detector is permanently disconnected (when it is OSE equipped), then the door can be closed in the dead man mode. The lower infrared detector has no effect on opening of the door.

It is also possible to connect the safety contact strip of the system to the resistance (8.2 k Ω) by a closed loop. The function is then the same as for the OSE strip and lower infrared detector. If the contact strip is not connected, then the 8.2 k Ω resistance must be connected to connectors X2:41 and X2:42. Without the resistance, automatic operation will not function.

When the pull switch (X2:8) is activated, the door opens to the top final position and remains there for the time set on the T3 timer (range 3 to 130 seconds). It will then close automatically.

With the step-by-step control (X2:7), the door can be opened and closed with a single button. When the button is pressed, the door opens to the final position, or it will stop after being pressed again. When pressed once again, the door closes to the final position or stops when the button is once again pressed. The door can be stopped at any time by pressing the STOP button.

When EPS is activated (disconnection between X2:1 and X2:10), the door is in alarm mode:

- FSTronic = the door immediately closes by gravity (if closing delay is not set up, there is a warning light).
- FSTronic 24 = the door immediately closes by auxiliary motor (if closing delay is not set up, there is a warning light).

During a power outage, the door will remain open until the voltage in the reserve battery drops below the limit of 21 V (time depends upon the condition and charge of the battery), it then will close to the bottom final position as during an alarm.

During an alarm closing, the door can be stopped by pressing the STOP button. It will remain stopped so long as the button is pressed. The lower infrared detector or OSE optical sensing strip only stops the closing without moving back. If the lower infrared detector or OSE optical sensing strip is disconnected for more than 10 seconds, the door starts to close again.

If the door is closed by the EPS signal, it can in case of emergency be opened to an intermediate position by the Emergency open button (X2:9). The door remains in the intermediate position (set by the additionally available limit switch on the motor – intermediate position) for the time set on the T3 timer (range 0 to 130 seconds). It will then close as during an alarm. The warning light does not begin to flash before such emergency opening. The function only applies if a 3 x 400 V network power feed is present.

In normal regime, the horn and warning light alert function sets off the horn and warning light for the duration set on the T1 timer (range 0 to 25 seconds) before the door will start to move. The warning light can be disabled by setting the timer to 0. If the warning light and dead man functions



are used, it is necessary to hold the button pressed in the required door movement direction and wait the set time of the warning light before until the door begins to move and reaches the desired position.

!!! IF ANY FUSE IS TRIPPED, IT IS POSSIBLE TO REPLACE IT AT THE SWITCHBOARD ONLY ONCE! IF IT IS TRIPPED A SECOND TIME, REPLACING IT AGAIN IS NOT PERMITTED!!!

!!! IF THE PROCEDURES STATED IN THE TECHNICAL DOCUMENTATION ARE NOT OBSERVED, THE WARRANTY CONDITIONS MAY BE VOIDED!!!

!!! IN CASE OF A MALFUNCTION IT IS FIRST NECESSARY TO DETERMINE THE CAUSE OF THE MALFUNCTION AND TO RECTIFY THE SITUATION! ONLY THEN CAN THE TRIPPED CIRCUIT BREAKER OR FUSE BE RESET AGAIN!!!

!!! IT IS FORBIDDEN TO INTERFERE WITH THE CIRCUITRY OF THE SWITCHBOARD AND CHANGE THEIR CONNECTIONS. IF THIS CONDITION IS NOT OBSERVED, THE SWITCHBOARD WARRANTY WILL NO LONGER APPLY!!!

!!! THE SWITCHBOARD CANNOT BE OPENED BY A PERSON WITHOUT APPROPRIATE TRAINING AND QUALIFICATION IN ACCORDANCE WITH, at minimum, Section 6 of Decree No. 50/1978!!!

Operating temperature of the FSTronic switchboard is +10°C to +35°C. If ambient temperature drops below +10°C or exceeds +35°C, the switchboard cannot be operated! In temperatures exceeding +25°C and less than +15°C, the battery life is reduced. In exceptional cases, the FSTronic switchboard can be operated in lower temperatures, to as low as -5°C, but only if input power is permanently connected in order to provide minimal warming of the control circuits.

4. Description of controls and terminal blocks

4.1. Description of functions set up on the DIP switch

DIP1 – activates signaling of the lower infrared detector on indicating LEDs

DIP2 – activates signaling of the upper infrared detector on indicating LEDs

DIP3 – activates automatic closing after opening by pressing the “open” button on the control panel. When pressed, the “open” button has the identical function as does the pull switch (i.e., after a time set on the T2 it will close automatically).

DIP4 – activates shortening of the automatic closing time after the photodetector is interrupted. If the function is activated and photodetectors are installed, the door will close immediately after passing through the photodetector and will not wait until the time T2 passes.

DIP5 – selects whether the lock on the control panel locks only the panel buttons (open/close) or also all external inputs on the terminal block (remote control...)

DIP6 – selects the response mode to collision with an obstacle when closing. It is possible to select either 1) that the door will only move back and stop if it collides with an obstacle, or 2) that upon colliding with an obstacle the door will fully open and after passing of time T2 try to close again (5 attempts in total).

DIP7 – selects whether the motor stop reacts to the bottom limit switch immediately or with a delay (“limit switch overrun”). This is appropriate for use if the bottom OSE safety strip is installed,



and due to its sensitivity an undesirable move back occurs when closing into the final position.

Actual value of final position overrun:

- GfA FS motor with 76/14 gearing and main cylinder diameter 324 mm = ca 20 mm
- MFZ FDF motor when set on shaft and main cylinder diameter 168 mm = 25 mm

DIP8 – selects activation of OSE safety strip signaling. If the OSE safety strip is not connected, it is necessary to disable its signaling on the panel. If conversely the OSE safety strip is connected, then its operation must be activated.

4.2. Description of function settings on the DIP switch

	POSITION	OFF	ON
1	lower infrared detector signaling	switched on	switched off
2	upper infrared detector signaling	switched on	switched off
3	automatic operation of the “open” button on the panel	switched off	switched on
4	shortening of closing after passing the photodetector	switched off	switched on
5	locking external inputs (impulse+pull)	switched off	switched on
6	obstacle detection during automatic closing	opens fully	opens partially
7	final position overrun	switched off	switched on
8	OSE activation	switched off	switched on

4.3. Description of control feature functions on the panel

internal – switch plate

a) buttons

- open = door opening
- stop = stops door movement
- close = door closing

b) key switch – lock

- control lock on the panel in “0” position = the open and close buttons are blocked
- when alarm is activated by the detectors, turn off and on with the key = alarm reset

c) LED switch plate

LED  (green LED) = network power
- normally on, flashing during movement

LED  (red LED) = OSE
- normally off, flashing when OSE is activated

LED  (yellow LED) = infrared detector
- normally off, flashing when infrared detector is activated

LED  (red LED) error(!)
- normally off, flashing if any of the alarms is activated



External – connectors on the DPS in the unit (terminal block X2)

a) input side (top part of the X2 terminal box)

- connectors marked \perp are common – (0V), inputs are activated by connecting to \perp

OSE – optical sensing strip

+(B) +12 V (brown receiver and transmitter)

-(W) 0 V (white receiver and transmitter)

O(G) output (green receiver and transmitter)

1 +24 V for powering the photocells and external devices

\perp 0 V for powering the photocells and external devices

2 lower infrared detector NC contact of the infrared detector for closing

\perp 0 V

3 upper infrared detector NC contact of the infrared detector for opening – against closing

\perp 0 V

4 open NO contact

\perp 0 V

5 stop NC contact

\perp 0 V

6 close NO contact

\perp 0 V

7 impulse NO contact (step by step)

\perp 0 V

8 pull NO contact (always opens and, safety features permitting, opens after time-out)

\perp 0 V

9 emergency NO contact (after alarm activation opens to intermediate position 1, times out and disengages the brake – closes with alarm closing)

\perp 0 V

10 EPS NC contact

\perp 0 V

11 reset NO contact – resets the unit

\perp 0 V

12 lock NO contact on the panel – if there is a detector alarm, resets

\perp 0 V

The other inputs are connected to the X1 power terminal block.

b) output side (bottom part of the X2 terminal block)

26 warning light 0V

27 warning light +24V

28 alarm COM

29 alarm NO

30 alarm NC

31 COM relay (for connectors X2:32 through X2:38)

32 no 230V – switched on when network power is present

33 battery power down – switched on if battery voltage is above 21.0 V

34 safety limit switches – switched on if safety limit switches disconnect

35 fall brake – switched on when fall brake is activated

36 intermediate position 1 – switched on in this position

37 open – switched on in this position

38 closed – switched on in this position

39 detectors 0V (closed 4.7 k Ω loop for connecting detectors between X2:39 and X2:40)

40 detectors +24V (closed 4.7 k Ω loop for connecting detectors between X2:39 and X2:40)



- 41 contact strip 8k2 - 0V (closed 8.2 k Ω loop for connecting contact strip between X2:41 and X2:42)
- 42 contact strip 8k2 - +24V (closed 8.2 k Ω loop for connecting contact strip between X2:41 and X2:42)

Timers for setting up times

- T1 time of warning light 0 to 25 s
- T2 time until automatic closing 3 to 130 s
- T3 time of emergency opening 0 to 130 s

Power terminal block (X1 terminal block) for FSTronic

- L1,L2,L3,N,PE power feed 3 x 400/230 V TN-S
- 1,2,3,PE drive motor
- 4 brake 0 V
- 5 common for limit switches
- 6 limit switch intermediate position 1 (emergency) NO
- 7 limit switch open NC
- 8 brake +24V
- 9 limit switch closed NC
- 10 safety limit switch NC
- 13,14 fall brake NC

Power terminal block (X1 terminal block) for FSTronic 24

- L1,L2,L3,N,PE power feed 3 x 400/230 V TN-S
- 1,2,3,PE drive motor
- 4,5 safety limit switch NC
- 6,7 limit switch open NC
- 8,9 limit switch closed NC
- 10,11 limit switch intermediate position 1 (emergency) NO
- 12 brake 0 V (220 Ω)
- 13 brake +24 V (220 Ω)
- 14,15 fall brake NC
- 16 auxiliary DC motor +24 V (max. 10 A)
- 17 auxiliary DC motor -0 V (max. 10 A)



5. Control panel

5.1. Control panel description

 **Somati**
system s.r.o.

Jihlavská 510/2c, 664 41 Troubsko

tel: +420 547 427 011

servis: +420 640 242 399

www.somati-system.cz

FSTronic

OPEN

STOP

CLOSE

LED indications on the switch plate:

 Light on = on

 Flashing = door moving

 Flashing = OSE strip

 1 flash = lower infrared sensor activated

 2 flashes = upper infrared sensor activated

 1 flash = EPS activated

 2 flashes = power outage

 3 flashes = battery out

4 flashes = safety limit switch

5 flashes = fall brake activated

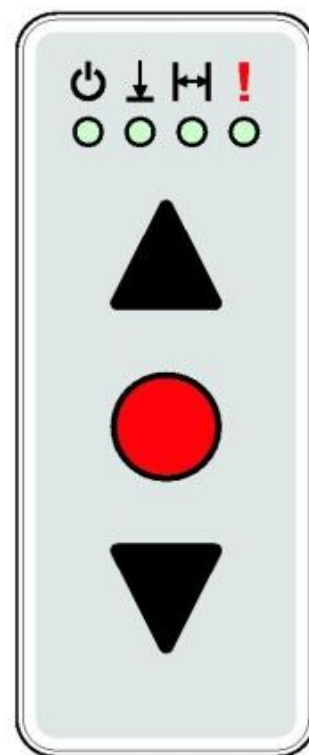

In case of several concurrent alarms, the individual alarms are displayed by short flashes with a pause in between.















A switch plate with Open, Stop and Close buttons is installed for controlling the FSTronic. LED lights on the switch plate display all possible states of the control so the door operator can easily determine the states and possible door alarms.

Description of the individual lights:

-  If the light is uninterruptedly on, the control is active.
 -  If the light is flashing, the door is moving

 -  Normally, the light is off and does not flash. If it flashes, the bottom OSE safety strip has been activated. If the bottom OSE safety strip is not installed it is flashing continually, which can be deactivated by switching DIP 8 to OFF.

 -  Normally, the light is off and does not flash. If it flashes, the lower or upper infrared sensor (a security element) has been activated. If the lower infrared sensor is not installed, it flashes continually, which can be deactivated by switching DIP 1 to ON. If the upper infrared sensor is not installed it will flash continually, which can be deactivated by switching DIP 2 to ON.
 -  If the light flashes 1x quickly, the lower infrared sensor was activated.
 -  If the light flashes 2x quickly, the upper infrared sensor was activated.
- If the two infrared sensors are activated concurrently, the two states are displayed consecutively, i.e. one flash – pause – two flashes.
-  Normally the light is off and does not flash. If the light is flashing, one of the alarms has been activated (see below).
 -  If the light flashes 1x quickly, EPS was activated. There is a fire alarm either from the central fire signaling or local detectors. If local detectors are installed, to disable the alarm it is necessary to turn off the key switch on the panel and turn it on again. This will RESET the detector. If it is an alarm from the central fire signaling, then the control alarm will be disabled automatically once the central fire signaling cancels the alarm, so there is no need to RESET using the key switch.
 -  If the light flashes 2x quickly, there is a power outage of the 3 x 400 V network.
 -  If the light flashes 3x quickly, this signals the battery is bad, voltage of the battery cells dropped below 21.0 V.
 -  If the light flashes 4x quickly, the safety limit switch has been activated. The door has passed over one of its standard end positions. **A service intervention is necessary.** The door can only be moved from this position by pushing the KM1 contactor (for movement upward, “otevřít”) or KM2 contactor (for movement downward, “zavřít”) by hand for such time as needed for the door to move by at least 5 cm. The contactor can only be pushed using a tool – ideally a slender insulated screwdriver. **This operation may only be performed by a trained and authorized person. In any case, a service intervention must be performed on the door mechanism to determine the cause for activating the safety switch.**
 -  If the light flashes 5x quickly, the safety fall brake has been activated. **A service intervention is necessary.** In this case, the “Close” button is blocked and the door can only be moved in the direction “Open” in the dead man mode. To unblock the fall brake, the door must very cautiously be opened by ca 5 cm, which should disengage the fall brake. Further, the micro switch on the fall brake must be deactivated (see the fall brake manual that was supplied). **This operation can only be performed by a trained and authorized person. In any case, a service intervention must be performed on the door mechanism to determine the cause of activating the safety fall brake.**

In case of several concurrent alarms, the individual alarms are displayed by short flashes with a pause in between (For example, 2 quick flashes – pause – 4 quick flashes means there was a power outage and at the same time the safety limit switch is activated.)



5.2. Door cycle counter on the control panel

The FSTronic controls have an integrated internal memory which can display the number of completed door cycles. The counter is supplied reset to zero after door installation. After replacing certain components (e.g., the motor) or a total overhaul of the door mechanism, the counter can be reset to zero. This operation is only performed by a trained service technician authorized for such operation (which needs to be entered into the door's service book).

















Displaying counter number:

The number can be displayed if the control (door) is in the stop state – not in alarm state.

Press the stop button on the switch plate and hold for 10 s

- 1) All the LEDs will light up momentarily.
- 2) All the LEDs will turn off.

Now the digit positions of the cycle count number will be displayed by the numbers of  LED flashes for the individual LEDs, as described below:

- 3) The  LED will light up – The  LED will flash as many times as there are 100,000s (hundreds of thousands) of cycles.
- 4) The  LED will light up – The  LED will flash as many times as there are 10,000s (tens of thousands) of cycles.
- 5) The  LED will light up – The  LED will flash as many times as there are 1,000s (thousands) of cycles.
- 6) The + LEDs will light up – The  LEDs will flash as many times as there are 100s (hundreds) of cycles.
- 7) The + LEDs will light up – The  LEDs will flash as many times as there are 10s (tens) of cycles.
- 8) The ++ LEDs will light up – The  LEDs will flash as many times as there are 1s (units) of cycles.

The display will automatically return to the normal mode.

Indicating the lapse of the service interval:

The FSTronic control panel is equipped with an internal memory that will display the passing of the preset service interval by synchronous flashing of all LEDs. The standard preset interval is 2,500 door cycles or 1 year from the last service (or installation). In case the passing of the service interval is signaled, it is necessary to call upon the service organization to perform a service check. The technician will check the door and put the controls back into their standard operating state. Even if signaling of the lapse of the service interval is active, all functions of the controls remain unaffected – only the display of alarms is affected by the synchronous flashing of the service interval.

6. Regular preventive checks

a) Switchboard

Component	Check	Action performed	Cycle
Terminal block	Loose screws Loose connectors	Tighten	1 year
Contactor, relay	Loose connections Visual check	Tighten Replace after check	1 year



b) Battery – mandatory user maintenance (the risk is a loss of function during a power outage)

Component	Check	Action performed	Cycle
Battery(ies) FSTronic	Time of door held open until battery is discharged – minimally 30 minutes. The guarantee for batteries for safety devices is 1 year.	Turn off power supply. If needed, <u>replace the batteries with brand new ones!</u>	1 year
Battery(ies) FSTronic 24	Closing the door by sounding the alarm – closing by the auxiliary DC motor minimally 5x in the entire cycle. The guarantee for batteries for safety devices is 1 year.	Turn off power supply. If needed, <u>replace the batteries with brand new ones!</u>	1 year

The FSTronic is equipped with hermetically sealed lead–acid batteries. The following instructions should be followed for their safe operation:

Proper recharging is a precondition for obtaining the full life from hermetically sealed lead–acid batteries (for usual types, this is ca 5 years at an optimal operating temperature of 15–20°C). This is provided by the FSTronic recharging circuit so long as the control panel is powered from the electricity network. In case of a network power outage for more than 2 hours, disconnect the batteries by disconnecting the connector so that the batteries do not discharge themselves in supplying the control panel. The battery connector should be insulated by covering with the plastic cover (see section 3 – installation). Under normal operating conditions, the battery is hermetically sealed, nothing should be leaking from the safety plugs and the battery can be operated in any position. In order to ensure the safe function of the seals (e.g. in case of a charger malfunction) it is necessary also to maintain some free space in front of the upper side that has the seals. Extreme discharging also decreases the life of lead–acid batteries. When the battery is fully discharged, it even can be damaged. New batteries are supplied partially charged. The optimal storage temperature is 15–20°C. Load must be disconnected when they are in storage! Before storing, it is necessary to charge the battery. During long-term storage at the listed temperature it is appropriate to recharge it after no more than 9 months, and sooner if the temperature is higher. With higher temperature the total life of a lead–acid battery significantly decreases.

SAFETY INSTRUCTIONS FOR HERMETICALLY SEALED LEAD–ACID BATTERIES:

- Maintain proper polarity – do not switch poles, keep contacts clean.
- Use them only for the electrical appliances for which they were designed.
- Hermetically sealed lead–acid batteries cannot be replaced by common car or motorcycle batteries.
- If the battery is overcharged even though the original charger is used, that means the charger is damaged. Disconnect the faulty charger immediately and have it repaired by a professional service center.
- **Chargers for common car or motorcycle batteries or chargers for nickel–cadmium, nickel–metal hydride or other types of batteries must not be used.**
- Protect the batteries from shorts. Do not overload or warm them. Do not place them into fire, open or modify or damage them in any other way.
- Dispose of old batteries properly at an appropriate collection facility.

Batteries damaged through improper use and **by not observing the principles stated above are not subject to guarantee!** In order to determine the causes of failure for a battery subject to a claim, the seller reserves the right to test the **specific operating conditions**. If improper conditions are confirmed, **the work related to their checking and measuring will be billed.**



7. Circuit diagrams

Connection of the FSTronic with the GfA – FS motor (in control box)

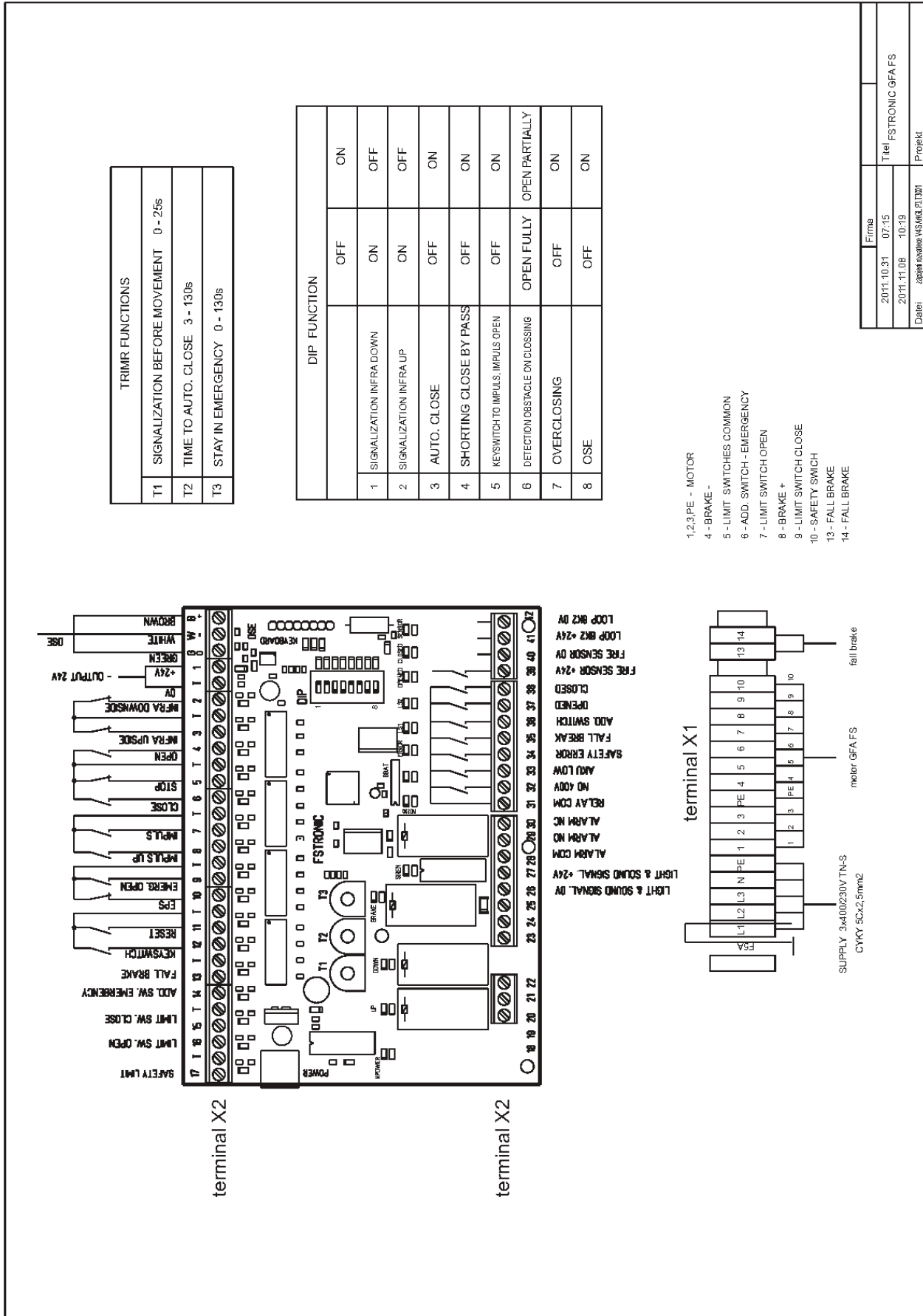

TRIMR FUNCTIONS	
T1	SIGNALIZATION BEFORE MOVEMENT 0 - 25s
T2	TIME TO AUTO. CLOSE 3 - 130s
T3	STAY IN EMERGENCY 0 - 130s

DIP FUNCTION			
1	SIGNALIZATION INFRA DOWN	OFF	ON
2	SIGNALIZATION INFRA UP	ON	OFF
3	AUTO. CLOSE	OFF	ON
4	SHORTING CLOSE BY PASS	OFF	ON
5	KEYSWITCH TO IMPULS. IMPULS OPEN	OFF	ON
6	DETECTION OBSTACLE ON CLOSING	OPEN FULLY	OPEN PARTIALLY
7	OVERCLOSING	OFF	ON
8	OSE	OFF	ON

- 1,2,3 PE - MOTOR
- 4 - BRAKE -
- 5 - LIMIT SWITCHES COMMON
- 6 - ADD. SWITCH - EMERGENCY
- 7 - LIMIT SWITCH OPEN
- 8 - BRAKE +
- 9 - LIMIT SWITCH CLOSE
- 10 - SAFETY SWITCH
- 13 - FALL BRAKE
- 14 - FALL BRAKE

Firma	
2011.10.31 07:15	Titel FSTRONIC GFA FS
2011.11.08 10:19	
Datum	Zapřít nově NS.Md. 21.10.11
	Projekt

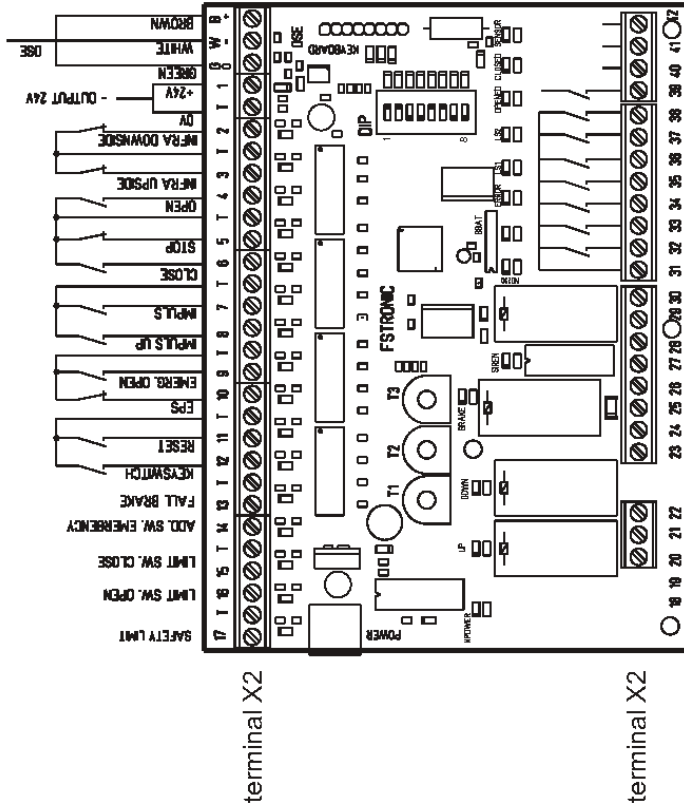
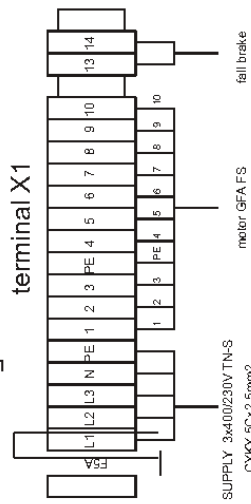



Connection of the FSTronic with the GfA – FS motor (in the motor)

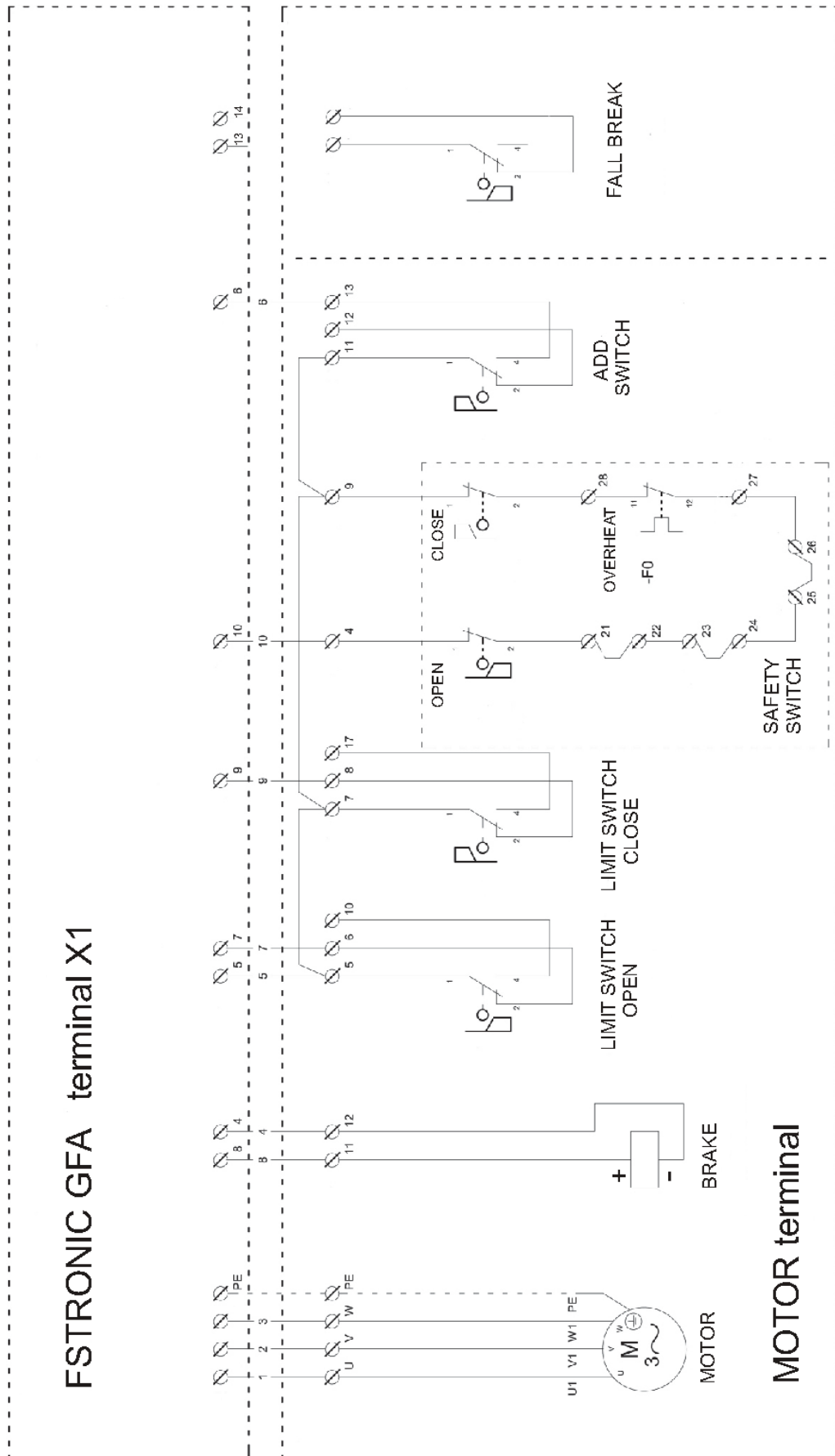



Connection of the FSTronic 24 with the MFZ – FDF motor (in control box)

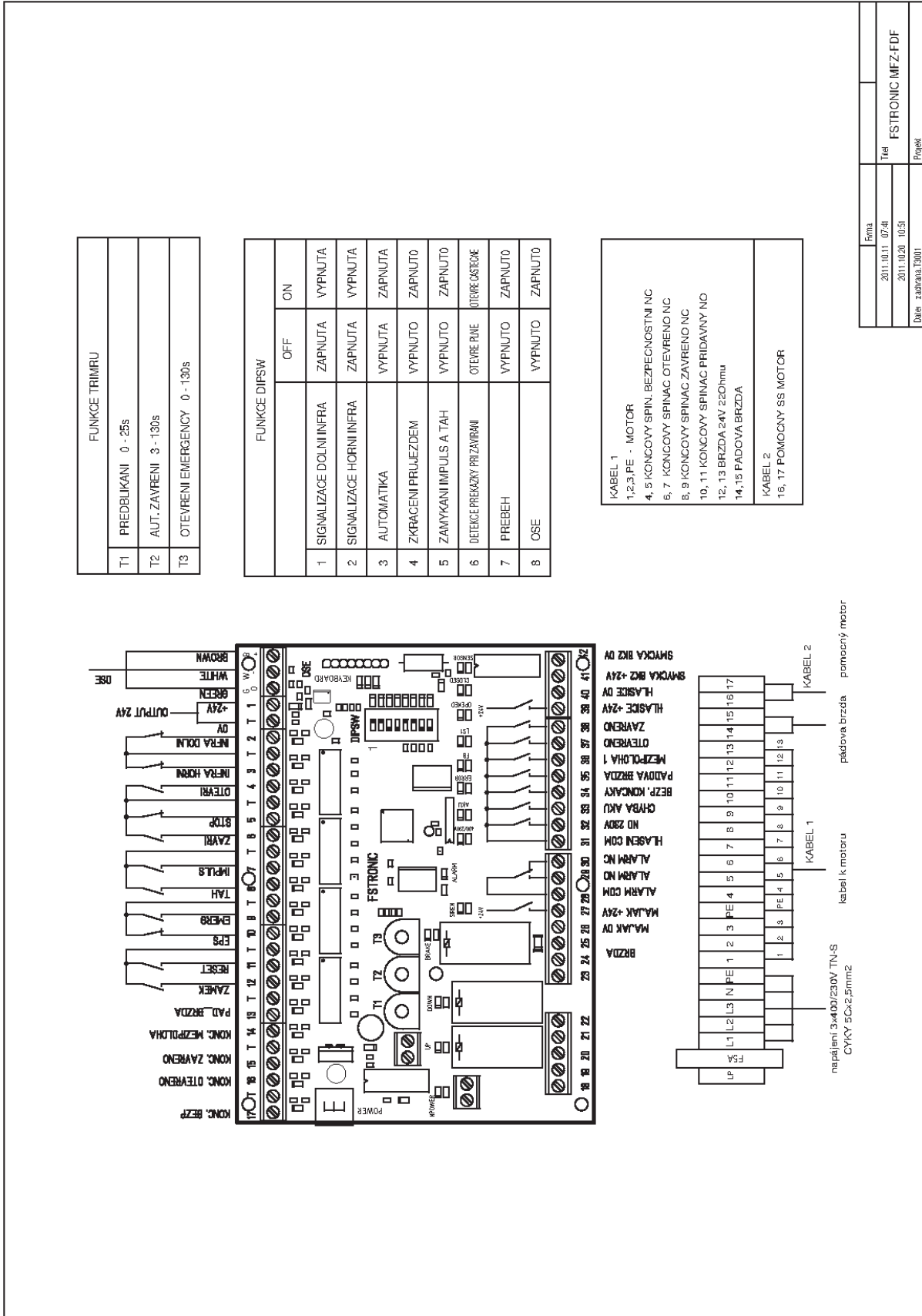

FUNKCE TRIMRU	
T1	PREDBLIKANI 0 - 25s
T2	AUT. ZAVRENI 3 - 130s
T3	OTEVRENI EMERGENCY 0 - 130s

FUNKCE DIPSW			
	OFF	ON	
1	SIGNALIZACE DOLNI INFRA	ZAPNUTA	VYPNUTA
2	SIGNALIZACE HORNII INFRA	ZAPNUTA	VYPNUTA
3	AUTOMATIKA	VYPNUTA	ZAPNUTA
4	ZKRACENI PRUJEZDEM	VYPNUTO	ZAPNUTO
5	ZAMYKANI IMPULS A TAH	VYPNUTO	ZAPNUTO
6	DETEKCE PŘEKROKY PRIZVABANI	OTEVRE PŘÍME	OTEVRE ČASTEČNE
7	PŘEBEH	VYPNUTO	ZAPNUTO
8	OSE	VYPNUTO	ZAPNUTO

KABEL 1	1,2,3 PE - MOTOR
	4, 5 KONCOVÝ SPINAC BEZPEČNOSTNÍ NC
	6, 7 KONCOVÝ SPINAC OTEVŘENO NC
	8, 9 KONCOVÝ SPINAC ZAVŘENO NC
	10, 11 KONCOVÝ SPINAC PŘIDÁVÁNÍ NO
	12, 13 BRZDA 24V 220Ohm
	14, 15 PÁDOVÁ BRZDA
KABEL 2	16, 17 POMOČNÝ SS MOTOR

Forma	FSTRONIC MFZ-FDF
Třída	
Datum	2011.10.11 07:41
Upraveno	2011.10.20 10:51
Projekt	

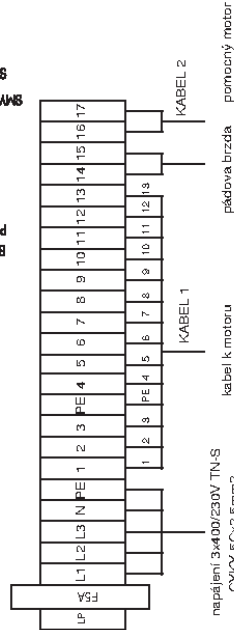

- BRZDA
- MAJAK DV
- ALARM COM
- ALARM NO
- ALARM NC
- HLASEN COM
- NO ZAVR
- CHYBA AKU
- BEZP. KONČARY
- PÁDOVÁ BRZDA
- MEZPOLOHA 1
- ZAVŘENO
- HLASICE +24V
- SMYČKA BRZ DV

- BRZDA
- MAJAK DV
- ALARM COM
- ALARM NO
- ALARM NC
- HLASEN COM
- NO ZAVR
- CHYBA AKU
- BEZP. KONČARY
- PÁDOVÁ BRZDA
- MEZPOLOHA 1
- ZAVŘENO
- HLASICE +24V
- SMYČKA BRZ DV

napájení 3x400/230V TN-S
 CYKY 5Cx2,5mm²

KABEL 1 kabel k motoru
 KABEL 2 pomocný motor
 PÁDOVÁ BRZDA
 KABEL 1
 KABEL 2



Connection of the FSTronic 24 with the MFZ – FDF motor (setting limit switches)

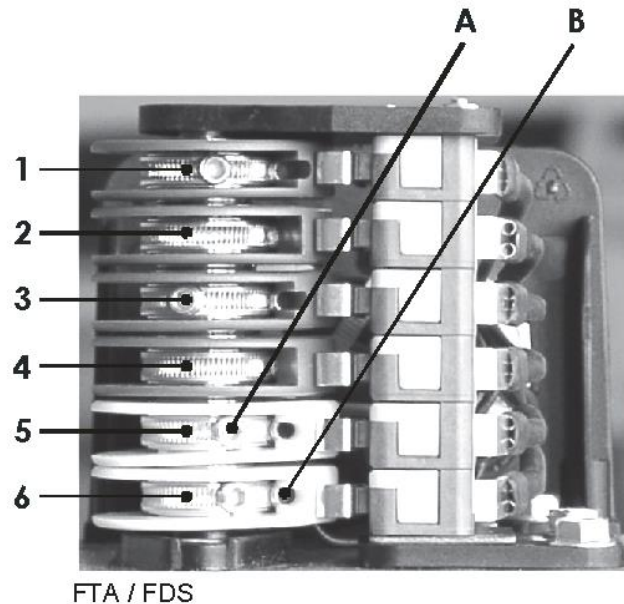
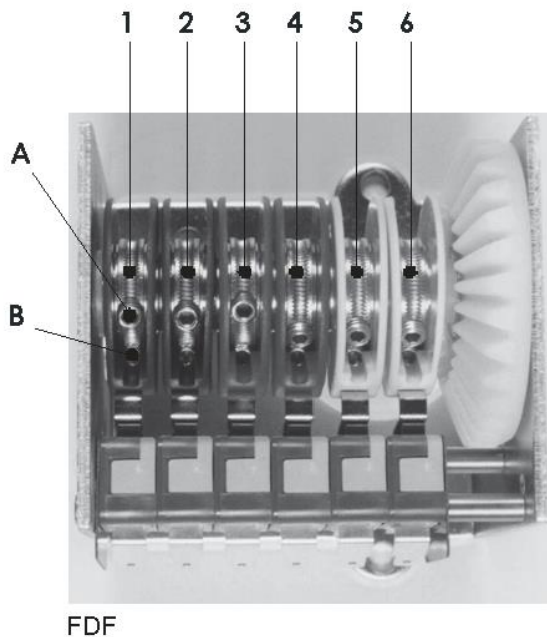

Adjustment of limit switch FDF motor (FTA / FDS)

FDF (FTA / FDS)

1. Additional limit switch OPEN green
2. Limit switch OPEN green
3. Safety limit switch OPEN red
4. Safety limit switch CLOSED red
5. Limit switch CLOSED white
6. Additional limit switch CLOSED white

- 1) Drive the gate to wished CLOSED position.
- 2) Set the control cam 5 (white) the way that the limit switch is operated.
- 3) Tighten the fixing screw A.
- 4) Fine adjustment is done with the screw B.
- 5) Drive the gate to wished OPEN position.
- 6) Set the control cam 2 (green) the way that the limit switch is operated.
- 7) Tighten the fixing screw A.
- 8) The safety limit switches 3 and 4 (red) must be set the way that they react directly after passing the control limit switch.
- 9) After the operation test, control the fixing screw.
- 10) The additional limit switches 1 and 6 have change-over contact free of potential.



EC Declaration of Conformity

Manufacturer:

Somati system s.r.o., Jihlavská 510/2c, 664 41 Troubsko
ID No. CZ29260159

Product:

ROLLTRONIC – FSTRONIC

Designed for controlling fire doors

Method of assessing conformity:

Tests were performed by the testing lab no. 1063 TESTCOM accredited by the Czech Accreditation Institute which issued the following protocols:

- On 3 April 2006 protocol no. EB1367-1, electrical safety
- On 28 April 2006 protocol no. 11/06 electromagnetic compatibility

List of technical regulations used in assessing conformity:

Government Decree No. 17/2003 Coll., on technical requirements for low-voltage devices, as amended; Government Decree No. 616/2006 Coll., on electromagnetic compatibility, as amended.

And the pursuant harmonized Czech technical norms: ČSN-EN60950-1:2003, ČSN-EN50130-4:1999, amendment A1:1999, amendment A2:2003, ČSN-EN61000-6-3:2002, ČSN-EN61000-4-2:1997, amendment A1:1990, amendment Z1:2001, ČSN-EN61000-4-3 ed. 2:2003, ČSN-EN61000-4-4:1997, ČSN-EN61000-4-5:1997, amendment Z1:2001, ČSN-EN61000-4-6:1997, amendment Z1:2001, ČSN-EN61000-4-11:1996, ČSN-EN55011:1999, amendment A1:2001, amendment A2:2003

The manufacturer hereby confirms that the properties of the product conform to the basic requirements according to government decrees nos. 17/2009 Coll. (2006/95 ES) and 616/2006 (2004/108 ES) Coll., or the requirements of other technical regulations and that the product is safe under the conditions of the aforementioned use. The manufacturer also has adopted measures to ensure conformity of all the products introduced to the market with the technical documentation and basic requirements.

In Troubsko on

Ing. Jiří Ruč, Somati system s.r.o.