



Somati

system s.r.o.

Control unit FSTronic IRC-FI

Designed for drives of sliding (or vertically moving with counter weight) fire gates with system of battery backup

Content:

1. Power supply	2
2. Configuration	2
3. Installation and setting.....	4
4. Connection of other external devices.....	11
5. Description of control and terminal blocks.....	13
6. Counter of cycles on control panel	24
7. Value report on the functional display	25
8. Errors on frequency inverter	27
9. Connectors.....	28
10. Control panel	30
11. Regular service.....	32
12. Circuit diagrams	34

version **STANDARD**



Vrersion **COMPACT**



1. Basic data and power supply

Casing size:	400 x 400 x 210 mm (W x H x D)
Weight:	23 kg (without batteries 18kg)
Installation:	vertically on the wall
Connection:	the inlets and outlets of the power and control circuits are via PG bushings on the underside of the switchboard
Voltage system:	1-N-PE, 50 Hz, 1 x 230 V, TN-S
Input fusing:	see table with versions and sizes according to frequency inverter ! if RDC (Residual current device) is used sensitivity not less than 100mA !!
Unit supply current:	0,3A without external devices and accumulators 0,6A without external devices and with charging Of accumulators. Current under load acc. to size
Operating voltage:	24 VDC
Output voltage for ext. devices:	max.24 VDC/1,2A – max for each output see details of outputs – sum cannot exceed max. 1,2A
Output voltage for motor brake:	103 VDC/0,3A
Output voltage for motor:	0÷125 Hz, 3 x 0÷230 VAC
Control inputs:	24V/10mA pro bezpotenciální kontakty
Accumulators:	part of control unit – 2pcs 12V/7-10Ah additional – up to 3 sets of 2pcs 12V/7-10Ah
Fusing of accumulators:	ceramic fuse 10x38 gG in disconnecting tube fuse F6,3A in transformer SCP-35-24
Operating temperature:	+10°C up to +35°C, at temperatures above + 25 ° C and below + 15 ° C the battery life decreases. Exceptionally, it can be operated at lower temperatures up to -5 ° C, provided that it is permanently connected to a power supply that provides heating of the circuits.
Air humidity:	max 93% without condensation
Degree of protection:	IP 54

Protection against electric shock is made according to ČSN 33 2000-4-41 by automatic disconnection of defective part from power supply and supplementary connection of safety circuits.

2. Configuration

FSTronic IRC-FI is designed to control drive of sliding (or vertically moving with counter weight) fire gates - using asynchronous motors (eg. EPO) with system of battery back up.

Power supply of control box is backed up by batteries to close gate (or to open gate) in case of power failure, using special battery backup system and frequency inverter. In case of power failure gate stays in position, in which the power failure occurred, for the set time

(0 - 30 min.) in parameter "8" or until the battery is discharged to a critical level – gate closes if the power supply is not restored and battery voltage drops below the limit 22,0 V.

Control box FSTronic IRC-FI is supplied in two basic types according to motor performance and size of frequency inverter:

FSTronic IRC-FI STANDARD:

Description of versions FSTronic IRC-FI with batteries in control unit		
series	2A	4A
Type of FSTronic	FSTronic IRC-FI 2A STANDARD	FSTronic IRC-FI 4A STANDARD
Main inner fusing	LTNB10 – 10A	LTNB10 – 10A
Type of inverter Yaskava	CIPR-GA50CB002EBAA-BAAASA With integrated filter	CIPR-GA50CB004EBAA-BAAASA With integrated filter
motors	EPO 120W	EPO 250W
	EPO 180W	EPO 350W

FSTronic IRC-FI COMPACT:

Description of versions FSTronic IRC-FI with batteries in control unit		
series	2A	4A
Type of FSTronic	FSTronic IRC-FI 2A COMPACT	FSTronic IRC-FI 4A COMPACT
Main inner fusing	LTNB10 – 10A	LTNB10 – 10A
Type of inverter Yaskava	CIPR-GA50CB002EBAA-BAAASA With integrated filter	CIPR-GA50CB004EBAA-BAAASA With integrated filter
motors	EPO 120W	EPO 250W
	EPO 180W	EPO 350W

FSTronic IRC-FI is available in the COMPACT version, this version differs from the basic version only in the range of standard equipment - the COMPACT version does not include a keyswitch lock on the control panel.

1. Installation and setting

Drive control unit is pre-set by parameter "r" for motor with which is delivered or for the weakest motor, control unit permanently verifies correct setting of frequency inverter parameters. It is necessary to set parameter for motor selection Parameter "r". To ensure proper operation we have to install appropriate type of control box designed for particular motor group or control box designed for a higher group of motors.

After connection of external control devices (controls and end switches) the drive requires only a control of function. It is important to ensure that the end switches function well. Their incorrect setting or electric connection can cause damage of mechanical part of gate. Before putting into operation the installation of mechanical part of gate has to be completely finished to avoid mechanical damage of gate when starting the motor. Before starting connect only:

1. Motor cable FSTronic IRC-FI (can be part of motor)

- **Motor power** - terminal block X4 terminals 1, 2, 3, S, PE (picture 1.1)
 - o terminal 1 (motor phase) – wire marking XM/U (eventually 1)
 - o terminal 2 (fáze motoru) – wire marking XM/V (eventually 2)
 - o terminal 3 (fáze motoru) – wire marking XM/W (eventually 3)
 - note. - by switching the motor phases, it changes the direction of rotation
- see point 3.1.1 setting the direction of movement
 - o terminal S (shielding of motor cable) – grey wire without marking
 - o terminal MPE (ground) – wire green-yellow

- **Communication cable of position sensor IRC** – end switches – terminal block X4 nterminals 4, 5, 6, 7, 8 (picture 1.2)
 - o terminal 4 (shielding of sensor cable) – grey wire without marking
 - o terminals 5 a 8 (power supply for sensor 24V)
 - terminal 5 (0V) – sensor wire marking X1/3 (eventually 5)
 - terminal 8 (+24V) – sensor wire marking X1/4 (eventually 8)
 - note - the polarity of the sensor power supply must be correct!!
 - o terminals 6 a 7 (output signal from sensor)
 - terminal 6 – sensor wire marking X1/1 (eventually 6)
 - terminal 7 – sensor wire marking X1/2 (eventually 7)
 - note - the output signals of the sensor can be reversed, this changes the direction and the direction of movement must be set / confirmed again, see.point 3.1

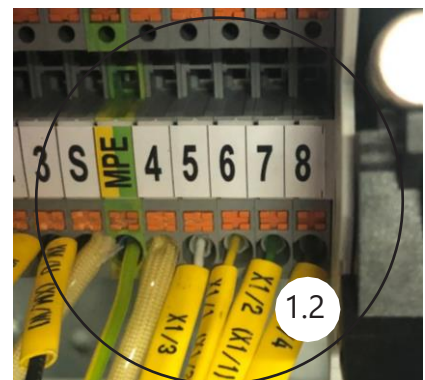
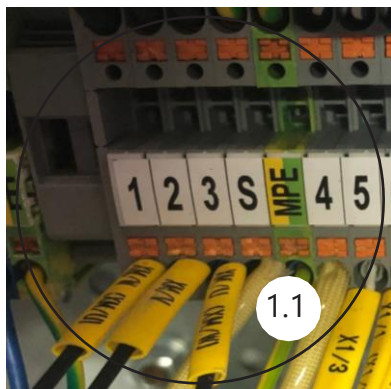

2. **Power cable** – terminal block X4 terminals L,N,PE

- ! Necessary to connect all wires including grounding. Without grounding (PE) can be unit damaged.

After connecting the switchboard to the mains, the batteries can be connected by inserting a fuse into the disconnecter, see point 3.7



3. **Connect terminals EPS - fire contact**

(X2:+ and X:10) by default set as input NC contact - can be changed by parameter (default setting when the door is open, the door is still in alarm). Originally supplied with the wire jumper marked "fire contact".

4. **Terminals of safety brake** - (X1:13 and X1:14)

or the IRC_FI version, this input is used to block the motor in the closed position. The input is NO, if it closes in the closed position then the motor is blocked - it is used for input of the inductive sensor of the door hook lock. Do not connect the terminals

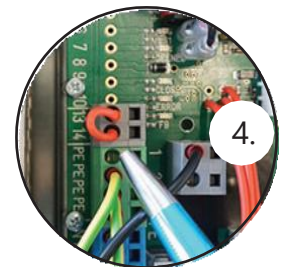

5. **Install key switch** - due to transport is delivered disassembled

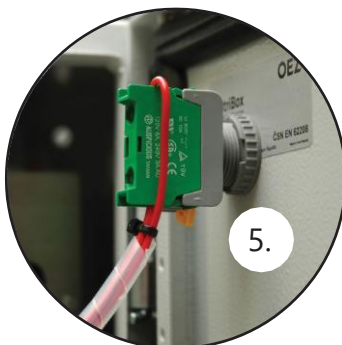

Note:

For version compact key switch is not part of standard delivery. Can be additionally added.

6. **External battery (voluntarily accessory), recommended only original accumulators - 24V (2x12V) with fusing**

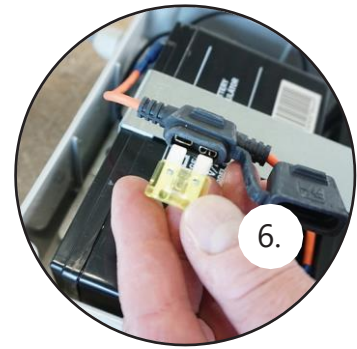
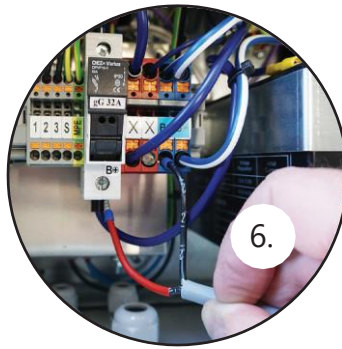
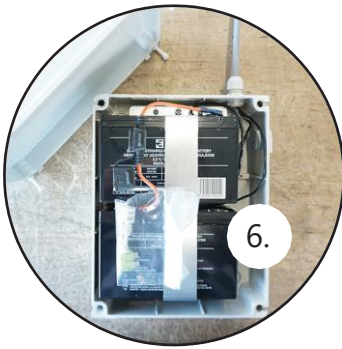

7. **Installation of the battery fuse. Fuse is delivered together with control unit, but is not inserted in connector. Is fixed on the door of control unit. Fuse type tubular fuse 10x38 gG32a.**

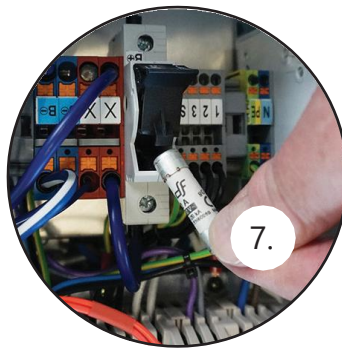
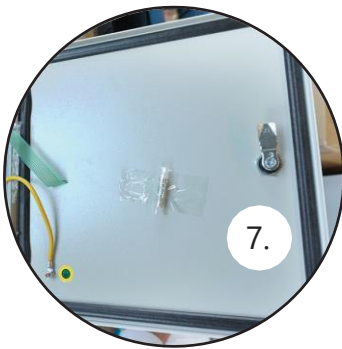

Do not connect any external controls or any other devices before setting the end switches – it can cause automatic start, which is not restricted due to the unset end switches.

Steps for connection to power:

Connect power supply and only then connect batteries (see point 7.)

Steps for disconnecting power:

First disconnect batteries and then disconnect power supply.

3.1. Setting of end switches IRC (incremental)

First check the value of parameter "r", if is equal to used motor.

- ! If the control panel has already been used in the past, we recommend performing a complete reset of the control panel by calling the function **ErSt** see the description in point 3.2

After switching on the control panel power supply, which has already been set in the past, an attempt will always be made to find the reference position. The display shows **ErrF** that no reference has been made (reference = end point search where the IRC sensor is reset, by default the reference point is set to the closed position)

Subsequently, a message **r CL** appears on the display or **r OP** which indicates that the door is looking for a reference point (r_CL = referencing to position closed, r_OP referencing to position open, see parameter **rP** settings)

The reference position is searched at reduced speed, see parameter settings **rE**

When searching for a reference at the moment of reaching the stop (end position), the drive is overloaded and after the time set by the parameter **tB** has elapsed, it evaluates as reaching the reference point and resets the position sensor. Unintentional evaluation of the end position can occur if the motor is overloaded when searching for a reference when there is no free movement of the door - check the door mechanism.

If the control panel was set up correctly in the past and the door mechanism has not changed, the drive is ready for use after searching for a reference point (reference).

During referencing, this process can be interrupted and new settings can be made, proceed according to point 3.1.1

3.1.1. Setting of movement direction:

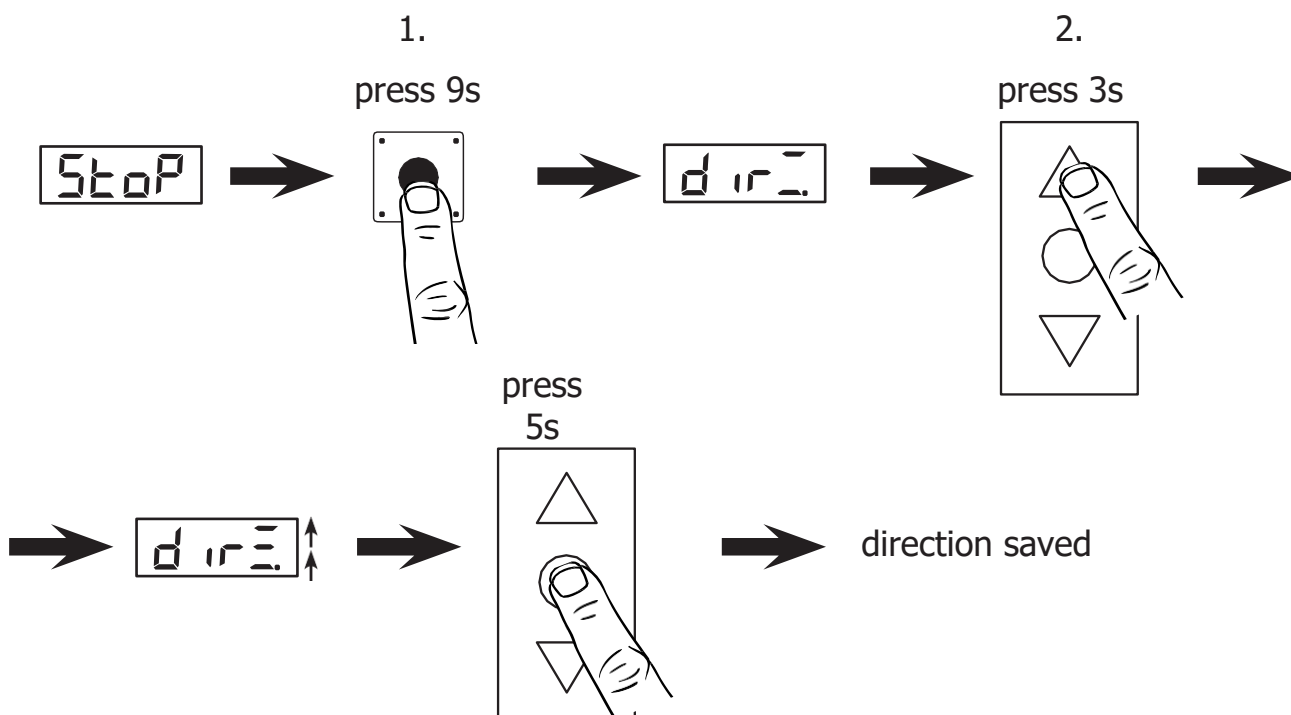

Setting is possible only from STOP state, "stop" must be shown on display.



- 1) press and hold knob button – during approx. 9 s. it passes to setting of movement, and display shows „ dir_ “
(by holding the knob button, after 4 seconds there is at first displayed „Par“ „Par“ it is

necessary to hold the knob button until display shows:

- a) „dir $\bar{_}$ ” – if two horizontal lines light, the direction has been already set
- b) „dir $\bar{_}$ ” – if two horizontal lines flash, the direction has not been set yet
- 2) Afterwards press keyboard buttons “open” or “close” (keyboard has to be unlocked by key switch), if the movement takes longer than 3 seconds, then three horizontal segments, shown on the display, start rolling in direction specified with keyboard. After releasing the button of movement direction, all three segments flashes:
 - if the actual direction of movement is different, it is necessary to switch 2 cable phase conductors to motor and repeat point 2) setting of movement direction
 - if the direction of movement corresponds, it is possible to save the setting – which can be done by pressing STOP button on keyboard and holding the button for 5 seconds.

After saving the direction of the movement (by holding STOP on keyboard for 5 seconds) we automatically proceed to setting of end switches.

It is possible to skip setting of direction („dir”) by pressing knob button – to get directly to setting of end positions. It is possible to use function „dir” for manual movement of gate in emergency situations – only used for service (for example in case of getting out of range of end positions or during the activation of safety end switches).

3.1.2. Setting of upper end position „opened”:

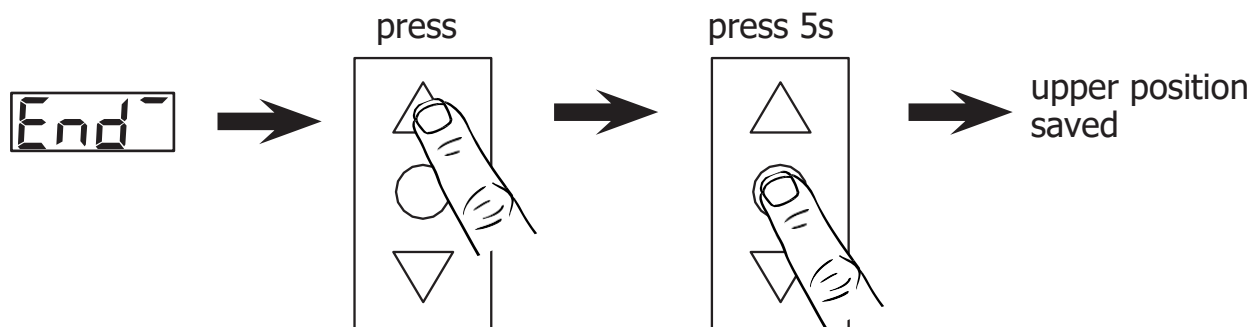

- 1) This setting is available automatically after saving the setting of direction or by pressing knob button, the display shows:
 - a) „End $\bar{_}$ ” – if the upper line lights, the position has been already set
 - b) „End $\bar{_}$ ” – if the upper line flashes, position has not been set yet
- 2) Afterwards press keyboard buttons OPEN or CLOSE (keyboard has to be unlocked by key switch) and move gate into position, in which we want to set the end position “opened”:
 - If the actual position of gate corresponds with the required position, it is possible to save the setting – by pressing STOP button on keyboard and holding the button for 5 seconds.
 - After saving the upper end position (by holding STOP on keyboard for 5 seconds) we automatically proceed to setting of middle position.
 - It is possible to skip setting of upper end position (in case it has been already set) by pressing button knob – then we proceed directly to setting of middle position.

3.1.3. Setting of middle position:

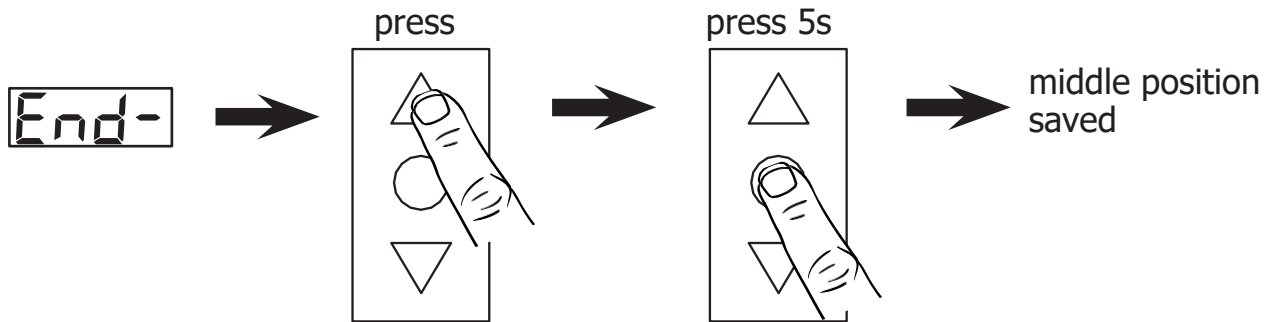

- 1) We can start setting of middle position after saving the position "opened" or by pressing button knob, there is displayed:
 - a) „End - “ – if the middle line lights up, the position has been already set
 - b) „End - “ – if the middle line flashes, position has not been set yet
- 2) Afterwards press keyboard buttons OPEN or CLOSE (keyboard has to be unlocked by key switch) and move gate into position, in which we want to set the middle position.
 - If the actual position of gate corresponds with the required position it is possible to save the setting – by pressing STOP button on keyboard and holding the button for 5 seconds.
 - After saving the middle position (by holding STOP on keyboard for 5 seconds), we automatically proceed to setting of lower end position.
 - It is possible to skip setting of the middle position by pressing the knob button – and proceed to setting of the lower end position – IT IS NECESSARY TO SET the middle end position to put the gate into standard operation, the middle position is used for additional functions (e.g. emergency open...)

3.1.4. Setting of lower end position „closed“:

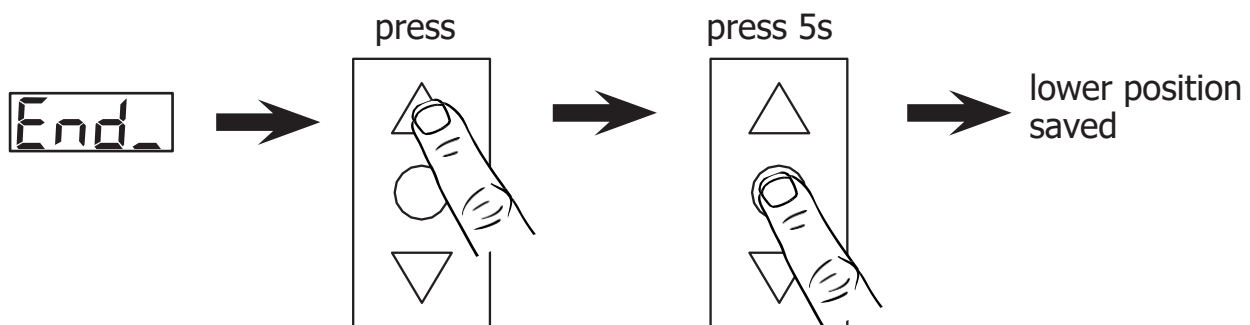

- 1) We can start setting of the lower end position after saving the middle position or by pressing the knob button, on display is shown:
 - a) „End _ “ – if the lower line lights, the position has been already set
 - b) „End _ “ – if the lower line flashes, the position has not been set yet
- 2) Afterwards press keyboard buttons OPEN or CLOSE (keyboard has to be unlocked by key switch) and move gate into position, in which we want to set the lower end position.

- If the actual position of gate corresponds with the required position it is possible to save the setting – by pressing STOP button on keyboard and holding the button for 5 seconds.
- After saving the lower end position (by holding STOP on keyboard for 5 seconds), we automatically proceed to calibration of opening time.
- It is possible to skip setting of the lower end position by pressing knob button – and proceed to setting of the calibration of opening time.

It is possible to use function „End -“ setting of end positions, for manual movement of gate in emergency situations – only used for service (for example, when passing the range of end positions or during the activation of safety end switches).

To put the gate into operation, it is necessary to do final calibration of operation time. This is a safety function, which is important when preparing gate for standard operation.

3.1.5. Calibration of time and torque (max. motor force)

Calibration of time and torque is a necessary task for the complete commissioning of the door. If this function is not performed correctly, an error **EEEE** will be displayed, ie a movement time error or a maximum torque error **OLER**. This function is safety and is used to check the movement time and the maximum torque during operation.

During calibration, the maximum running time between the end positions is measured also the maximum torque when moving the door - this maximum torque can be exceeded during standard door movement by the value set by the parameter **OL**, thus increasing insensitivity in the event of an obstacle. The time for which the maximum torque can be exceeded is set in parameters **ER** and **EB**

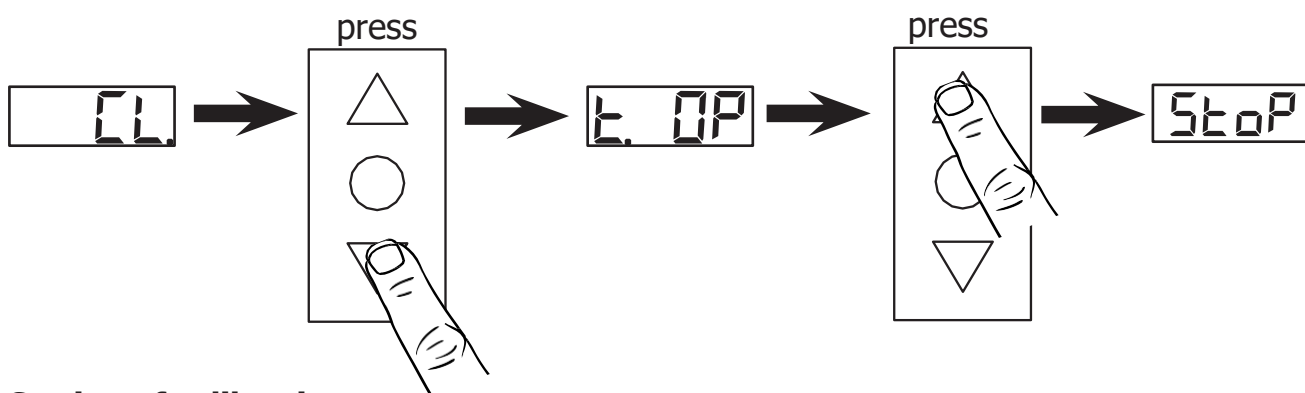

Setting of calibration:

It is important to set lower ("closed") and upper ("opened") end position.

- 1) Display shows „CL“ – by pressing keyboard button CLOSE – to get to position “closed” (position “closed” has to be set). After setting the position “closed” the motor stops and display shows „t OP“
- 2) By pressing keyboard button OPEN and its holding (without interrupting) we get into position “opened” (position “opened” has to be set). In “opened” position the motor stops and unit goes to normal operation – setting of direction and positions is successfully completed)

If the pressing/holding of keyboard button is interrupted before reaching the opened position, the setting automatically returns to point 1) and it is necessary to repeat the calibration process. You have to return to position “closed” and repeat the calibration process.

It is possible to terminate the calibration by pressing knob button – however, the calibration of time is not set and the unit cannot work automatically.

3.2. Complete reset of unit

If necessary it is possible to make complete reset (e.g. in case of using on other motor). Deletes end positions calibration of the time all parameters will be set to default and parametr "r" will be set for weakest motor r=1.

Deleting is possible only from STOP state, on display must be shown

Press and hold knob button – after approx. 20s the delete operation starts, on display is shown "ErSt". Reset must be confirmed.

- a) If we press knob button – we return to STOP state without deleting)
- b) If we turn the knob, select "YES" and press knob button – the deletion is accomplished and we return to "STOP".
- c) If we turn the knob, select ESC and press knob button – we return to STOP without deletion.

4. Connection of other external devices

After testing the setting of end positions (IRC) it is possible to continue with connection of other external devices.

Control box FSTronic DES-FI is standardly equipped with keyboard buttons „Open“ and „Close“, which can be used to open the gate in "Dead man" mode. For automatic operation (one-press start) upwards, it is necessary to connect terminals X2:+ and X2:3 by connection or safety device. If it is possible to hang on the surface of gate leaf or to pass an object through the gate, it is necessary to add a safety device "upper safety sensor" to maintain automatic operation

Automatic operation close is activated by connecting safety sensor „lower safety sensor“ with terminals X2:+ and X2:2 („lower safety sensor“) or by connecting optical safety edge OSE with terminals X2:G and X2:W and X2:B (ATTENTION - OSE safety bar must be activated, see 5.2.1 - DIP8. If the safety sensor is disconnected (or OSE or contact strip is activated) during closing, gate moves back and stops (see setting of DIP6 and selection of parameter „4“).

In case the „lower safety sensor“ is disconnected (or OSE or contact strip is activated) permanently, it is possible to close the gate in "Dead man" mode. "Lower safety sensor" has no influence on opening of gate.

It is also possible to connect safety contact strip of the system with closed loop by resistance (8,2k Ω) – this function is identical with the function of OSE or "lower safety sensor". If the contact strip is not connected, terminals X2:39 and X2:40 has to be connected to resistance 8,2k Ω - without the resistance the automatic operation does not work.

When pull switch (X2:8) is activated, gate opens into the open end position and remains in this position for a time set in parameter „6“, then the gate automatically closes.

Control Step-by-step (X2:7) enables to open and close gate with a single button. When we press

the button, the gate starts to open to the end position or stops after we press the button again. When we do another press of the button, the gate starts to close to the end position or after another press of the button the gate stops. The gate can be stopped anytime with button STOP.

When EPS (fire alarm system) is activated – contact between X2:+ and X2:10 is disconnected and gate is in alarm mode = the gate immediately closes (if there is not set a closing time for delayed closing – pre-flash) or opens in case of set functionality for “ventilation”.

In the event of a power failure, the door will remain in the open position according to the setting of parameter "8". If the parameter "8" is set to "-", the battery capacity is controlled and they remain in position for a maximum of until the voltage on the backup battery falls below the 22 V threshold (the time depends on the condition and charge of the battery). Then they close to the lower end position by closing as in the alarm state.

During the alarm closing it is possible to stop the gate with STOP button– it is stopped as long as the button is held, „lower safety sensor“ or optical safety edge OSE stops the closing without moving back. If the „lower safety sensor“ or optical safety edge OSE is disconnected longer than time set in parameter (default 10 sec), the gate starts to close again.

In case the gate is closed by fire alarm (EPS, detectors..), it is possible to do an emergency open into the middle position using button Emergency open (X2:9). In the middle position (set according to parameter "9") gate remains for the set time in parameter „A“, then it is closed like in alarm mode. A pre-flash is not set before this emergency open. The function only applies in case of present power supply 1x230V or if the backup power is correctly dimensioned. In parameter „O“ – it is possible to select maximum of 10 attempts to open, however it is dependent on status of battery charge and its size.

Function of audio and visual signalization (Pre-flash) causes that during the set time in parameter „2“, before the standard operation of gate, signalization starts functioning (flash and sound = warning light). When using function „Pre-flash“ and „Dead man“ it is necessary to permanently hold pressed button in required direction of gate movement and wait until the end of set time of pre-flashing before the gate starts moving into the required position

IF SAFETY DEVICES (FUSES) IN CONTROL BOX ARE BLOWN, IT IS POSSIBLE TO TURN THEM ON ONLY ONCE – IF THEY ARE BLOWN ONCE MORE, IT IS NOT PERMITTED TO TURN THEM ON AGAIN

IF THE PROCEDURE STATED IN THE TECHNICAL DOCUMENTATION IS NOT RESPECTED, IT MAY LEAD TO THE LOSS OF WARRANTY

IN THE EVENT OF MALFUNCTION, FIRST IT IS NECESSARY TO DETECT POSSIBLE CAUSE OF THE MALFUNCTION AND REPAIR IT. AFTER THE MALFUNCTION IS REPAIRED, IT IS POSSIBLE TO TURN ON THE BLOWN FUSE AGAIN.

IT IS FORBIDDEN TO MANIPULATE WITH CIRCUITS OF THE CONTROL BOX AND CHANGE THEIR CONNECTIONS. IN THE EVENT OF FAILURE TO COMPLY WITH THIS CONDITION, IT IS NOT POSSIBLE TO APPLY WARRANTY ON THE CONTROL BOX

CONTROL BOX CANNOT BE OPENED BY A PERSON WITHOUT APPROPRIATE TRAINING AND QUALIFICATION ACCORDING TO THE DECREE No. 50/1978, §6

5. Description of control and terminal blocks

5.1. Func

Terminal block of function FUNC is used to internal functional connection of the control box, nothing has to be connected on this terminal block.

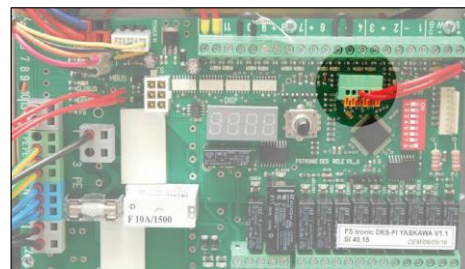

5.2. DIP switch

5.2.1 Description of DIP switch functions

DIP1 – activates signalization of lower safety sensor on LED indicator

DIP2 – activates upper safety sensor on LED indicator

DIP3 – activates automatic closing after opening by pressing "open" button on the keyboard of control panel, "open" button has same function in case of activation as pull switch (i.e. after setting time in parameter „6", gate is automatically closed)

DIP4 – activates shortening of automatic closing time when passing safety sensor. If the function is activated and safety sensors are installed, the gate immediately closes when passing the safety sensor and does not wait to the end of the set time in parameter „6"

DIP5 – selects if lock on the control panel only locks the panel buttons (open /close) or it also locks all external inputs on the terminal block (e.g. remote control...)

DIP6 – selects response mode to collision with an obstacle during closing. It is possible to select either 1) that the gate only moves back and then stops or 2) that after collision the gate fully opens and after the end of set time in parameter „5" it tries to close again (number of attempts for closing is set by parameter „4")

DIP7 – no function

DIP8 – activates signalization of safety edge OSE – in case safety edge OSE is not connected, it is necessary to cancel its signalization on the panel. If OSE is connected, then we have to activate its function.



5.2.2. Description of setting functions on DIP SWITCH

POSITION	OFF	ON
1 lower safety sensor	ON	OFF
2 upper safety sensor	ON	OFF
3 "open" button Placed on control panel	OFF	ON
4 shortening of closing when passing safe. sensor	OFF	ON
5 locking of external inputs impulse+pull	OFF	ON
6 detection of obstacle during automatic closing	fully opened	partly closed
7 no function		
8 activation of OSE	OFF	ON

5.3. Description of functions on display device

5.3.1. Control of menu on display

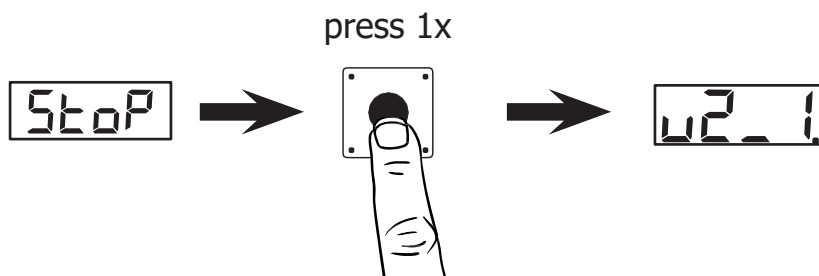

1x press shows actual version of program.

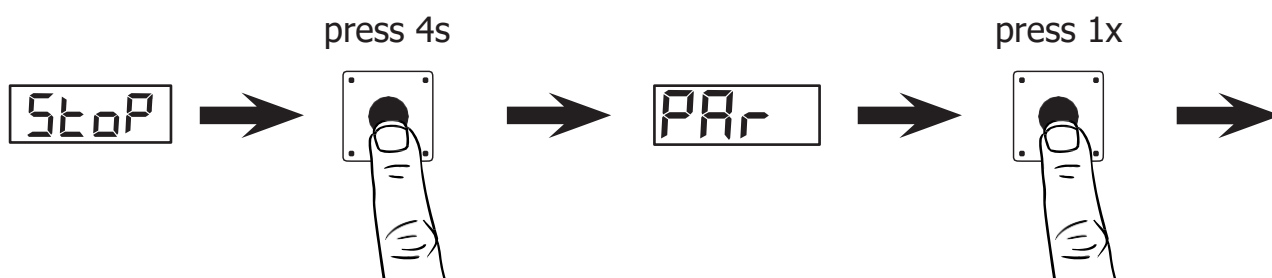



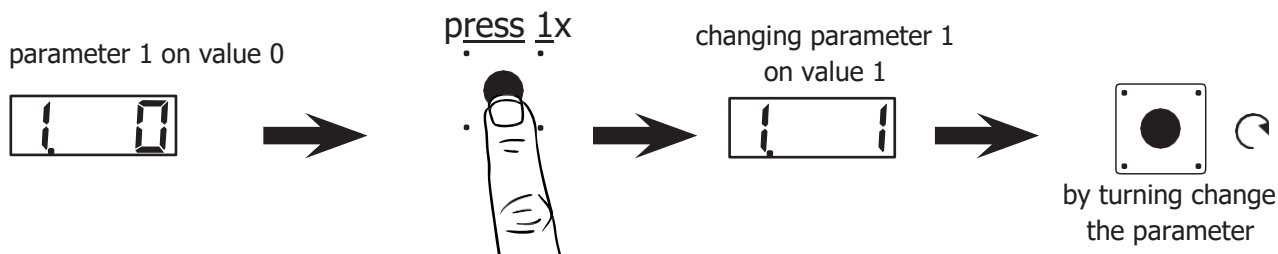











Description of setting of optional parameters on display device. To enter the setup we have to hold knob button and after 4 seconds display shows „Par”.

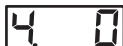

After displaying „Par” press knob button to display the individual parameters and their set value.

By turning the knob button you can display individual parameters and after pressing the knob button you can start to change the set values of the particular parameter – the value flashes. The parameter value can be changed by turning the knob button and after reaching the required value, it can be saved by pressing the knob button. If we do not want to change the parameter value, then we have to turn by the knob until the display shows „ESC” and then by pressing the knob button we move forward.

5.3.2. Parameters and their values

- | | | | | | | | | | | | | | |
|---|--|---------------------|-------------------------|--|------------------|--|----------------------------|--|------------------|--|------------------|---|--|
| <p>1. Parameter - Audio & visual signalization
 - warning light (output X2:26, X2:27)</p> <table border="0" style="margin-left: 40px;"> <tr> <td style="padding-right: 20px;"><u>during movement</u></td> <td><u>during alarm</u></td> </tr> <tr> <td>• 0 = active with delay</td> <td>active with delay, during alarm duration</td> </tr> <tr> <td>• 1 = not active</td> <td>active with delay, during alarm duration</td> </tr> <tr> <td>• 2 = active without delay</td> <td>active without delay, only during movement</td> </tr> <tr> <td>• 3 = not active</td> <td>active without delay, only during movement</td> </tr> <tr> <td>• 4 = not active</td> <td>active with delay, only during movement</td> </tr> </table> | <u>during movement</u> | <u>during alarm</u> | • 0 = active with delay | active with delay, during alarm duration | • 1 = not active | active with delay, during alarm duration | • 2 = active without delay | active without delay, only during movement | • 3 = not active | active without delay, only during movement | • 4 = not active | active with delay, only during movement | 
 |
| <u>during movement</u> | <u>during alarm</u> | | | | | | | | | | | | |
| • 0 = active with delay | active with delay, during alarm duration | | | | | | | | | | | | |
| • 1 = not active | active with delay, during alarm duration | | | | | | | | | | | | |
| • 2 = active without delay | active without delay, only during movement | | | | | | | | | | | | |
| • 3 = not active | active without delay, only during movement | | | | | | | | | | | | |
| • 4 = not active | active with delay, only during movement | | | | | | | | | | | | |
| <p>2. Parameter – Time of pre-flash - alarm
 Range of values: 0–999 seconds,
 Note: In case of setting time delay follow rules in standard EN 14637.
 Default = 0</p> | 
 | | | | | | | | | | | | |
| <p>3. Parameter – Time of pre-flash under normal operation
 Range of values: 0–999 seconds,
 Note: (when setting parameter „1” “warning light” on value 1, there is running only the time of pre-flash, warning light is not active)
 Default = 0</p> | 
 | | | | | | | | | | | | |
| <p>4. Parameter – number of attempts to close
 Range of values:
 • 0-10 attempts
 • „-” = endless number of attempts
 Note: (according to the setting DIP6 gate moves back or fully opens) Default = 0</p> | 
 | | | | | | | | | | | | |
| <p>5. Parameter – delay of closing attempts
 Range of values: 1–50
 seconds Default = 10</p> | 
 | | | | | | | | | | | | |
| <p>6. Parameter – time of automatic closing
 Time after which the gate, opened by pull switch, starts to close. Range of values: 3–999 seconds
 Default = 10</p> | 
 | | | | | | | | | | | | |
| <p>7. Parameter – duration of movement back
 Motion back after collision with obstacle.
 Range of values: 1–10 seconds
 Default = 3</p> | 
 | | | | | | | | | | | | |

A Parameter – time of battery discharging

Time after which the gate, held on batteries, closes during power failure. Range of values:

- 0-30 minutes
- „-“ = depends on battery condition and load Default = 10

A 10
A 30

9 Parameter – Emergency Open width

Setting of width for automatic open in alarm and activation of button Emergency Open (input X2:+, X2:9) Range of values:

- 30–100 % gate width
- „-“ = according to the setting of middle position

Note: When we have end switches NES it is possible to set only „-“ and the position follows the setting of middle position.

Default = 50%

9 50
9 100

A Parameter – Emergency Open time

Setting of time during which the gate waits in the set position after activation of button Emergency Open.

Range of values: 5–999 seconds Default = 10

A 10
A 60

b Parameter – Permanent Open

Selection of input function of pull switch (input X2:+, X2:8)

- 0 – without permanent open – standard pull switch
- 1 – function “permanent open” is activated – if the input of pull switch is connected then it opens always when it is possible – closes only in alarm
- 2 – function permanent close Default = 0

b 0
b 1

C Parameter – Return after alarm

What happens after cancelling the alarm:

- 0 = after cancelling the alarm, do nothing
- 1 = return to the state before alarm
- 2 = after alarm Open
- 3 = after alarm Close
- 4 = after alarm Reset will finish closing as the alarm will be active Default = 0

C 0
C 3

d Parameter – Passing of closed position

Is used to pass the end position “closed” during alarm – can close the door beyond the end position when closing the alarm - special application.

Range of values: 0–100 % from 6 % gate height. Default = 0

d 0
d 100

E Parameter – time of Smoke alarm

E 10

Time in which the gate remains in alarm „Smoke” i.e. in position partly opened before closing again:

- 5–999 seconds
- „-” = time unlimited

Default = 10

E 360

F Parameter – length of opening time in case of Smoke alarm activation

F 50

- 0–100% gate width
- „-” = according to the setting of middle position

Note: When we have end switches NES it is possible to set only „-” and position follows the setting of middle position.

Default = 50 %

F 70

H Parameter – do not monitor OSE / Ledge 8K2

H 1 H 100

The width from which the safety edge of OSE

is not monitored to prevent the unwanted opening before the contact with stop profile.

Range of values: 1–100 % from 10 promiles of gate width

Default = 30 %

J Parameter – correction of the end position “opened”

J 0

Range of values: -99 – +99 % from 1 % gate height

Default = 0

J 100

L Parameter – correction of the end position “closed”

L 0

Range of values: -99 – +99 % from 1 % gate height

Default = 0

L 100

r Parameter – selects type of motor for correct setting of frequency inverter

r - 1

We select the type of motor and the control box enters, into the frequency inverter, the appropriate parameters of the particular motor for its proper and smooth operation.

r - 11

Note: Control boxes FSTronic IRC-FI are supplied in two sizes of frequency inverter see the table, [point 2](#).

Value „r”	Motor type	Type od sensor	Power of inverter
1	EPO 120W	IRC	2 A
2	EPO 180W	IRC	2 A
3	EPO 250W	IRC	4 A

Value „r“	Motor type	Type od sensor	Power of inverter
4	EPO 350W	IRC	4 A
„r“	Individual motor settings	„r“ = motor parameters according setting on frequency inverter note: Warning, this value can be used only based on agreement with the producer. Only for special applications for non-standard motors.	

0. Parameter – attempt to open gate using backup power

-0–10 attempts

Default = 0



This parameter is significantly dependent on sizing of backup power hardware according to the motor size and gate dimensions. Backup power is primarily designed only for closing of gates.

Note: No influence on setting function ventilation **P-01**

1. Parameter – opening speed

Range of values: 40–250 %

Value shows how many percents from maximum frequency 50 Hz (primary set on frequency inverter) will be the speed of opening (100 % = 50 Hz)

Default = 80 %



2. Parameter – closing speed

Range of values: 40–150 %

Value shows how many percents from maximum frequency 50 Hz (primary set on frequency inverter) will be the speed of closing (100 % = 50 Hz)

Default = 80 %



3. Parameter – acceleration time

Range of values: 10–50 (1–5 seconds) steps 0,15

Value shows length of acceleration ramp in seconds (35 = 3,5 seconds), higher value means slower and smoother motor acceleration.

Default = 1,5 seconds



4. Parameter – field of deceleration open position

Range of values: 1–10 %

Value of the length distance before reaching open end position. Value is shown in percent of traveling distance.

Default = 3 %



E. Parameter – field of deceleration closed position E. 15

Range of values: 1–10 %

Value of the length distance before reaching bottom end position.

Value is shown in percent of traveling distance.

Note: In case of roller gate influenced by non linearity of roll up diameter.

Default = 3 %

11. Parameter – cross optocell 11. 0

Possible to set functionality of safety sensor (input X2:+,X2:2) for cross connection.

Opportunity to use two optocells with cross safety beams under door leave. During closing gate will be functionality of safety sensor deactivated when reached position set by LS1 so moving door leaf will not activate the sensor. Necessary to set right position LS1.

When this parameter set on value 1 then safety sensor between LS1 and bottom position is not active. (Typical application for conveyors – vertically moving door)

Range of values:

- 0 = normal
- 1 = cross optocell

Default = 0

h. Parameter – speed in alarm mode h. 40

Range of values: 20–150 %

Value shows how many percents from maximum frequency 50 Hz (primary set on frequency inverter) will be the speed in case of alarm (100 % = 50 Hz).

By reducing of this speed possible to reach longer operation from battery backup.

Default = 40 %

Parameter - service period (cycles) 3

service period 1 - 50 cycles, steps in 1000 cycles

Note: 0 = 10 cycles

Default = 3 (3000 cycles)

Parameter - conveyor confirmation 0

type of reaction when activated input "SMOKE" (X2:43 and X2:44)

0 = standard function "SMOKE"

1 = conveyor confirmation - in case of alarm and running time delay can be gate closed immediately when activated this input. When conveyor is clear gate can close quicker.



Default = 0

Parameter - initial alarm braking time 10



Allows you to select the length of the stop time in case of the FIRST activation of the safety device during closing in alarm.



Range of values: 1–999



second/s Default = 10



 **Parameter - another alarm braking time** 
 Allows you to select the length of the stop time in case of the SECOND and EVERY OTHER activation of the safety device during closing in alarm. Range of values: 1–999 second/s
 Default = 10



 **Parameter - type of input EPS - fire contact (X2:10, X2:+)** 
 0 = NC input normally closed
 1 = NO input normally opened
 Default = 0

 **Type of relay output 400/230V power (X2:31, X2:32)** 
 0 = power on - closed, power off - opened
 1 = power on - opened, power off - closed
 Default = 0

 **Type of relay output AKU (X2:31, X2:33)** 
 0 = AKU ok - closed, AKU fault - opened
 1 = AKU ok - opened, AKU fault - closed
 Default = 0

 **Type of relay output ERROR (X2:31, X2:34)** 
 0 = ERROR - closed, no ERROR - opened 1
 = ERROR - opened, no ERROR - closed
 Default = 0

 **Type of relay output FB safety brake (X2:31, X2:35)** 
 0 = FB closed - closed, FB opened - opened
 1 = FB closed - opened, FB opened - closed
 Default = 0

 **Type of relay output LS1 middle position (X2:31, X2:36)** 
 IRC – digital/incremental end switchec
 0 = from LS1 till closed - closed, from closed till LS1 - opened
 1 = from LS1 till closed - opened, from closed till LS1 - closed

NES (version ATEX)
 0 = at LS1 - closed, out of LS1 - opened
 1 = at LS1 - opened, out of LS1 - closed

Default = 0

- Lr6 Type of relay output open position (X2:31, X2:37)** Lr60
 0 = at position - closed, from closed till position – opened
 1 = at position - opened, from closed till position - closed
 Default = 0
- Lr7 Type of relay output closed position (X2:31, X2:38)** Lr70
 0 = at position - closed, from position till opened – opened
 1 = at position - opened, from position till opened – closed
 Default = 0
- P-0 Type of mode: Fire / Ventilation** P-00
 0 = Fire mode
 reaction on alarm (EPS, detectors, smoke and battery alarm) = closes the gate
 1 = Ventilation
 reaction on alarm (EPS, detectors, smoke) = open the gate. In
 case of battery alarm - no reaction)
 Default = 0
- S-E Servis end - settings of reaction in case of passing set value in parameter service period (time or cycles)** S-E0
 0 = after passing value - flashing diodes
 1 = after passing value - flashing diodes + totman
 2 = after passing value - flashing diodes + totman + by pressing stop for 3 seconds
 prolonged period for 500 cycles.
- SE Service period (time)** Setting amount of months. Range of values: 3-60 months SE.12
 Default = 12 months (year)
- P Speed in setting mode „dir“** P.100
 Allowed adjust speed for setting mode “dir” in percentage from set speed by parameter “t”,
 Range of values: 20-100 %
 Default - 100 %
 (the speed value is purposefully reduced to 30% due to the fact that it does not slow down in the "dir" movement and the door then tends to hit the end positions, in this reduced speed the setting of the desired position is also more sensitive without influencing door dynamics)
- rt Speed in reference mode** rt20
 Setting of speed during referencing – searching reference point
 Percentage from opening speed ste by parameter “t”,
 Range of values: 20-50 %
 Default = 20 %

rP**REFERENCE****rP. 1**

Setting the behavior of the drive during referencing

0 = reference point in closed position + monitors infra

1 = reference point in closed position + do not monitor infra

2 = reference point in opened position + monitors infra

3 = reference point in opened position + do not monitor infra

Default = 0

PC**Pushing door in closed position****PC. 1**

Setting the behavior of the drive in the closed position

0 = no reaction

1 = in the case of a mechanical pull from the closed position, it goes into the counter-pull and tries to close again

2 = in the end position it constantly pushes gently to the closed position (frequency 3Hz) this function is activated to heat the engine to heat the oil in the gearbox, use in installations with a temperature below freezing

PO**Pushing door in closed position****PO. 0**

Nastavení chování pohonu v otevřené pozici

0 = no reaction

1 = in the case of a mechanical pull from the opened position, it goes into the counter-pull and tries to open again

2 = in the end position it constantly pushes gently to the opened position (frequency 3Hz) this function is activated to heat the engine to heat the oil in the gearbox, use in installations with a temperature below freezing

EA**Duration of overload – start-up****EA30**

Range of values: 1–50 (0,1–5 sec.) steps in 0,1sec

Setting of the time for which the evaluation of the overload during start-up is limited.

Default = 30 (3 sec)

EB**Duration of overload – normal run****EB. 3**

Range of values: 1–10 (0,1–1 sec.) steps in 0,1sec

Setting the time for which the evaluation of running overload is limited. By increasing the value, it is possible to limit the evaluation of overload so that there is no inappropriate evaluation of overload with a short-term increase in resistance when moving the door

Default = 3 (0,3 sec)

OL**Overload****OL. 1**

Range of values: 1–10 (10-100%) steps in 10%

Setting the value of the permitted exceeding of the maximum torque measured during time and torque calibration. Increasing the value increases the torque (force) of the drive before evaluating the overload.

Default = 3 (30%)

- 5A Engine slip – start-up** 5A.70
 Range of values: 3–99%
 Asynchronous motor slip setting during start-up (the higher the value, the "harder" the motor and the higher the power and the lower the sensitivity to overload)
 Default = 70%
- 5b Engine slip – normal run** 5b.30
 Range of values: 3–99%
 Asynchronous motor slip setting during normal run (the higher the value, the "harder" the motor and the higher the power and the lower the sensitivity to overload)
 Default = 30%
- nr Drive dead band** nr. 0
 Range of values: 0–99 impulses of the IRC sensor
 Setting of the zone when the drive does not evaluate the overload during start-up and provides maximum power for pulling out of the stop position. Used when it is necessary to pull out of the closed position, where blockage can occur due to increased friction.
 Default = 0 impulsů
- o0 Field of signalisation opened position** o0. 0
 Range of values: 0–99% (percentage of the set movement width)
 Setting of the band when the end position opened is reported on the output relay of terminals X2:31, X2:37. It is possible to shift the message to control other devices.
 Default = 2%
- oC Field of signalisation closed position** oC. 18
 Range of values: 0–99% (percentage of the set movement width)
 Setting of the band when the end position closed is reported on the output relay of terminals X2:31, X2:38. It is possible to shift the message to control other devices.
 Default = 2%
- uU Maximum motor voltage** uU. 18
 Range of values: 5–23 (50 – 230V) po 10V
 Setting the maximum output voltage of the motor supplied by the frequency converter. As the value increases, the "hardness" of the drive increases (the higher the value, the "harder" the motor and the higher the power and the lower the sensitivity to overload)
 Default = 180V
- DEF Reset to default parameters** YES
 By choosing "YES" will set all parameters to default values ESC
 expect parameter "r", "u", "U", "y", "Y", "h" a "P"

Note: Some of the default parameters can be different against described values above for some specific types of motors. By resetting parameter "r" (type of mode) will be changed parameters "r", "u", "U", "y", "Y-mirror", "h" a "P" for optimal value for chosen motor. These parameters is possible to individually adjust but as mentioned above will be reset to default when changed parametr "r".

6. Counter of cycles on control panel

Control box FSTronic has built-in internal memory, from which it is possible to display the state of performed cycles of gate. Counter supplied after installation is reset. After change of some components (e.g. motor) or after the complete overhaul of mechanical device of gate, it is possible to reset the counter values– this operation can be done only by a trained service technician, who is entitled to do the operation (it is necessary to record that into the gate service book).

6.1. Displaying counter values

If the gate is in Stop state, it is possible by turning the knob button to display individual cycle values one by one:

Operating counter – from putting into operation

P - XX = operating counter XX -- --
 P - XX = operating counter -- XX --
 P _ XX = operating counter -- -- XX

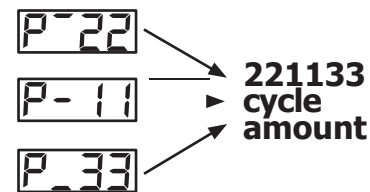

Alarms counter - from last service

A - XX = service counter XX -- --
 A - XX = service counter -- XX --
 A _ XX = service counter -- -- XX

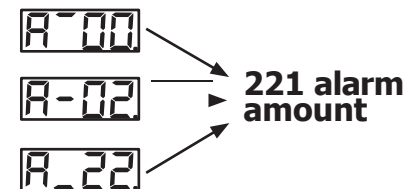

Service counter cycles – from last service

S - XX = service counter XX -- --
 S - XX = service counter -- XX --
 S _ XX = service counter -- -- XX

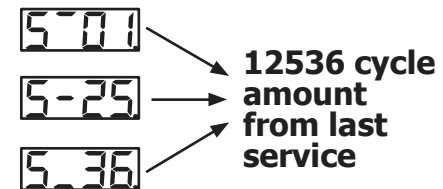

Service counter time – from last service

t - XX = service counter XX -- --
 t - XX = service counter -- XX --
 t _ XX = service counter -- -- XX

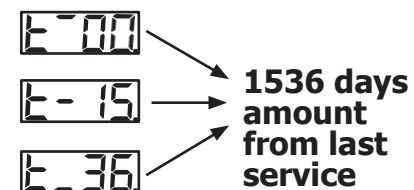

! **Note:** Reset can be done only by trained service. **!**

How to reset: Press button up + down at once for 10 seconds. All diodes will shortly flash - signal for successful reset done.

6.2. Indication of the end of service intervals

Control box FSTronic is equipped with internal memory, which displays end of pre-set service interval by simultaneous and synchronized flashing of all diodes. Standard interval is pre-set on 3000 cycles (see setting of parameter \overline{E}) or 1 year (see setting of parameter \overline{SE}) from the last service (or putting into operation). In case of the signalization of the end of service interval it is necessary to contact service organization to do the service inspection. After the inspection of gate, control is set into the standard operation mode again. Even when signalization of the end of service interval is activated, all control functions stay unchanged – only displaying of alarms is affected by synchronized flashing of service interval.

7. Value report on the functional display



Little LED in bottom right corner quickly flashes (nearly continuously ON) according to the communication with encoder in the motor. If flashes with interruptions than communication is incorrect – in this case check connection of communication cable or setting DIP7.

If sign STOP quickly flashes then is disconnected input X2:+, X2:5 or is pressed button STOP on the keyboard - this blocks movement of the gate.

If gate is in STOP mode (no movement) it is possible by turning knob display another information values as described in 6.1 and following:

$\overline{6Hr2}$















Indication from end switch DES 2B hexa – (e.g. 6Hr2).

$\overline{A242}$

Indication of voltage on low voltage circuit. In case of connected batteries indicated voltage on battery. A 24.2 = 24.2 V

7.1. Základní stavy zobrazované na displeji

- \overline{StRt} After reset.
- \overline{InIt} After reset it initializes.
- \overline{StOp} Stop. If flashes see point 7.
- \overline{rCL} searching reference point in closed position
- \overline{rOP} searching reference point in opened position
- \overline{OP} Opening.
- \overline{CL} Closing.
- \overline{EOP} „Time open“ calibration of opening time – only during the setting.

-  Opening "deadman".
-  Closing "deadman".
-  Waiting for automatic closing 88 = seconds.
-  In position 1 flashing „A/L“ i.e. alarm.
 In position 2 it displays:
 - „F“ - alarm from EPS input X2:+, X2:10
 - „b“ if the time ended (discharged) or the battery voltage dropped and power supply is not present
 - or nothing
 In position 3 it displays:
 - „d“ - detector alarm input X2:41-X2:42
 - or nothing
 In position 4 it displays:
 - „S“ - SMOKE alarm input X2:43-X2:44
 - or nothing
-  Movement back upwards – reversal after collision with an obstacle.
-  Waiting for closing after movement back XX = seconds.
-  In SMOKE alarm it goes to position SMOKE.
-  Time SMOKE until alarm (e.g. 12 seconds).
-  Return from alarm into the position before alarm - opening – only DES setting of parameter „C „ in 1
-  Return from alarm into position position before alarm – closing - only DES setting of parameter „C „ in 1
-  movement back upwards after passing the lower end position – „repeated movement back“
-  In alarm opens to position set for emergency open.
-  Countdown for time to close in emergency open.

7.2. Errors report on functional display

E_rrF

Flashes as a basic error because the drive reference has not been performed. It is necessary to switch the drive off and on again and call up the drive referencing, see 3.1

E_dE_r

Error IRC failure of communication.

E_tE_r

It did not reach the position in time, went to "stop", can be reset by new impulse to movement. If this alarm is repeated it is necessary to recalibrate time see 3.1.5. In specific cases with special motors where is longer acceleration under the load can be detected this fold then set parameter "U" and both "y" on maximum values and then recalibrate the time. After recalibration can be parameters "U" and both "y" reduced to previous values.

E_FE_r

Error of movement direction, went to „stop“, can be reset by new impulse to movement from the keyboard of the control box, external inputs are blocked. Before correction of the error, the keyboard of the control box must be locked and unlocked, otherwise it does not react. (3.1.1.–3.1.5.)

E_EE_r

Error of EEPROM – internal memory for saving parameters, end switches and counter. If the data do not correspond, they can be reset by restart.

E_CE_r

Error of control amount position IRC. Indicated when deleted end positions or by internal error. In case of this fold reset end positions (3.1.1.–3.1.5.).

E_PE_r

Error of limit switches activation of safety switch, error of position. Reset positions (3.1.).

E_SE_r

Error of time calibration. Set the calibration time (3.1.5.).

o_LE_r

Overload error - The drive has been overloaded. The error is reset by a new impulse to move. If repeated, the time and torque must be recalibrated, see section 3.1.5. Time and torque calibration.

E_bE_r

Torque Error - Stopped by drive overload. The error is reset by a new impulse to move. If it is repeated, the engine power setting must be adjusted or the time and torque must be recalibrated, see section 3.1.5. Time and torque calibration

F_bE_r

Activation of input safety break (input X1:13,X1:14). Used for connection of door lock sensor - see 1.4

8. Errors on frequency inverter

List of errors on frequency inverter - see manual of the inverter YASKAWA AC V1000.

In case of fault "OC" (over current) or "SC" (short circuit) immediately disconnect motor cable and check if there is not short circuit.

If this fault is repeated also when the motor cable is disconnected then the frequency inverter is damaged.

9. Connectors

9.1. Connectors on DPS - (terminal block X1)

4-10	free without functions
13, 14	„safety brake“ – input for door lock sensor
PE, N, LP, L1, L2, L3	internal connection in unit

9.2. External - terminals on DPS in the contr. box (terminal block X2)

a) Input side (upper part of the terminal block X2)

Terminals marked „+“ are common – (+24 V), inputs are activated by connecting to „+“

OSE – optical safety edge







+ (B)	+12V	(brown receiver and transmitter)
- (W)	0V	(white receiver and transmitter)
O(G)	output	(green receiver and transmitter)

1	+24 V	to power safety sensors and external devices
.	0 V	to power safety sensors and external devices
2		“LOWER INFRA” - NC contact of safety sensor for closing
+	+24 V	
3		„UPPER INFRA“ - NC contact of safety sensor for opening
		– against closing. <i>It also serves to connection of safety sensor of passage door – i.e. always during operation and disconnection of the contact, gate closes (without moving back)</i>
+	+24 V	
4		OPEN – NO contact
+	+24 V	
5		STOP - NC contact. <i>NOTE: Used only as input STOP, do not connect any functional blocking of the drive. Functional blocking connect only to input "upper infra</i>
+	+24 V	
6		CLOSE – NO contact
+	+24 V	
7		PULL SWITCH STEP-BY-STEP - NO contact
+	+24 V	

8	PULL SWITCH - NO contact (always opens and if the safety devices allow that the gate closes after the end of set time)
+	+24 V
9	„EMERGENCY OPEN - NO contact - after activation during alarm gate opens into position set by Par „9“, and after the end of set time Par „A“ it closes in alarm closing mode
+	+24 V
10	FAS (EPS) „fire contact“ – type of input according to setting Parameter <input type="checkbox"/> type of input EPS
+	+24 V
11	RESET – NO contact
+	+24 V
12	LOCK - NO contact on the panel – in case of detector alarm, it resets
+	+24 V

The remaining inputs are connected to the power terminal block X1.

b) output side (lower part of the terminal block X2)

26	warning light 0V
27	warning light +24V
	Maximum load of output warning light 24VDC/1A
28	alarm NO
29	alarm NC
30	alarm COM
31	relay COM (terminals X2:32 to X2:38)
32	without 230V – output according setting 
33	discharged battery - output according setting 
34	safety end switches - output according setting 
35	safety brake/ loack of the gate – output according setting 
36	middle position LS1 - output according setting 
37	opened – output according setting 
38	closed - output according setting 
	Maximum load of output relays X2:32 - X2:38 -max.60V DC/AC, 1A each, 5A total for all
39	contact strip 8k2 - 0V (to connect contact strip we use closed loop 8,2 kΩ between X2:39 and X2:40)
40	contact strip 8k2 - +24V (to connect contact strip we use closed loop 8,2 kΩ between X2:39 and X2:40)
41	smoke/heat detectors 0V (to connect detectors we use closed loop 4,7 kΩ between X2:41 and X2:42)
42	smoke/heat detectors +24V (to connect detectors we use closed loop 4,7 kΩ between X2:41 and X2:42)
43	Function of „Smoke“ alarm – when detector is activated, gate opens into the set position and after the end of set time it closes. detectors used for function „Smoke“ alarm 0V (to connect detectors we use closed loop 4,7 kΩ between X2:43 and X2:44)
44	detectors used for function „Smoke“ alarm +24V (to connect detectors we use closed loop 4,7 kΩ between X2:43 and X2:44)

9.3. Power terminal block (terminal block X4)

L, N, PE	power supply 1 x 230 V TN-S
1, 2, 3	drive motor phases
S	sheilding of motor cable - connected with ground
PE	ground of motor cable
4	sheilding of cable IRC sensor
5, 8	power supply of IRC sensor
6, 7	output signal from IRC sensor

10. Control panel

10.1. Key switch

- Keys switch on control panel in position 0 = buttons "Open" and "Close" not active, eventually not active also external inputs see setting DIP 5 point 5.2
- In case of activation of fire detectors - switch on and switch off = reset of alarm

10.2. Descriptions of control panel

- ▲ **OPEN** = button open gate
- **STOP** = button stop, by continuous pressing for 10 seconds is activated reset of fire detectors
- ▼ **CLOSE** = button to close gate

On control panel of FSTronic there is installed keyboard with buttons OPEN, STOP, CLOSE. On the keyboard there are also LED diodes, which display all current states of the control. This enables the gate operator to determine particular states and potential gate alarms.

10.2.1. Description of individual LED diodes:



If the diode is permanently ON, control is activated.
If the diode flashes (0,5s – 0,5s), gate is in motion.
If the diode flashes quickly (0,1s – 0,1s), running countdown for delay of movement.
If the diode is off, key switch is off - keyboard is not active.



Standardly, the diode is OFF and does not flash. If the diode flashes, the optical safety edge OSE was activated. If the OSE is not installed then the diode keeps flashing, this display can be deactivated by switching DIP 8 into position OFF).



Standardly, the diode is OFF and does not flash. If the diode flashes, the lower or upper safety sensor was activated. If the lower safety sensor is not installed then the diode keeps flashing, this display can be deactivated by switching DIP 1 into position ON. If the upper safety sensor is not installed then the diode keeps flashing, this display can be deactivated by switching DIP 2 into position ON..

If the diode does **1 short flash**, the lower safety sensor is activated.

If the diode does **2 short flashes**, the upper safety sensor is activated.

In case both safety sensors are activated at the same time, they are displayed one by one i.e. 1 flash – pause – 2 flashes.



Standardly the diode "!" is OFF and does not flash. If the diode flashes, one of the alarms is activated (see below).

In case of all LEDs flashing at once passed service interval. See point 6.2

10.2.2. Overview of alarms

- If the diode does **1 short flash**, the EPS (fire alarm system) is activated – fire alarm is activated by central fire signalization or by local detectors. If the local detectors are installed, to cancel the alarm it is necessary to switch the key switch ON and OFF on the control panel or press button STOP continuously for 10 seconds – which causes RESET of detector. If the alarm is activated by central fire signalization, the alarm is cancelled automatically – it is not necessary to do the RESET with key switch.
- If the diode does **2 short flashes**, power supply 1x230V has failed.
- If the diode does **3 short flashes**, it signals poor battery, voltage of battery cells dropped below 22,0V.
- If the diode does **4 short flashes**, safety end switches are activated – gate passed one of its standard end positions. Service intervention is necessary.
- If the diode does 5 short flashes, safety brake is activated. Service intervention is necessary. In this case the button CLOSE is blocked and gate can be operated only in direction OPEN and in "Dead Man" mode. To unblock the safety brake, it is necessary to carefully open the gate about approx. 5cm – which should unblock the safety brake. Then it is necessary to deactivate microswitches on safety brake (see manual of supplied safety brake). This operation can be done only by an authorized person with appropriate training. In any case it is necessary to do the service of mechanical device of gate to determine cause of the safety brake activation.

- If the diode does 6 short flashes, alarm of frequency inverter is activated – check setting of parameter „r“ size of motor. If everything is set correctly and the error is repeated, it is necessary to contact service – frequency inverter is overloaded

In case that several alarms are activated at the same time, they are displayed one by one by appropriate number of flashes with a short pause between each displayed alarm (e.g. 2 short flashes – pause – 4 short flashes. i.e. power supply has failed and at the same time safety end switch has been activated).

In case of all LEDs flashing at once passed service interval. See point 6.2

11. Regular service

11.1. Control box

Component	control	Performed operation	Cycle
Terminal block	Loose screws Loose connectors	Tighten	1 year
Contactora, relay	Loose connections Visual control	Tighten Replacement after control	1 year

11.2. Battery – required user maintenance

Failure to do so may result in loss of function in the event of a power failure.

Component	control	Performed operation	Cycle
Battery modules FSTronic	Time of holding the gate in open position until the battery is discharged – for at least 30 minutes. Warranty for battery of safety devices is one year.	Disconnection of main power supply or Replacement of batteries with new ones!	1 year

Control box FSTronic DES-FI can be equipped with hermetic PB batteries. To secure their safe operation the following conditions apply:

Precondition for reaching full life of the hermetic PB batteries is their proper charging (life of common types of batteries is approx. 5 years during optimal operating temperature 15-20°C). Charging is provided with charging circuit of FSTronic if the control panel is connected to power supply. In case of power failure longer than 2 hours, disconnect batteries by connector disconnection to avoid battery discharging due to powering of control panel – it is necessary to insulate battery connector with plastic cover (see point 3 – putting into operation). Under normal operating conditions, battery is hermetically sealed, no leak from safety plugs and battery can be operated in any position. To maintain function of the safety plugs (e.g. in case of charger failure) it is necessary to leave free space in front of the upper side containing safety plugs. Life of PB batteries can be also reduced if they are repeatedly fully discharged. If the battery is permanently fully discharged it may also cause its damage. New batteries are standardly supplied partially charged. Optimal storage temperature is 15-20°C. During storage the load has to be disconnected! Before storage, the battery has to be charged and during long-term storage (at the recommended temperature) it is necessary to recharge the battery at least every 9 months. If the storage temperature is higher it is recommended to recharge the batteries more often. Higher temperature significantly decreases the average life of PB batteries.

11.3. Safety instructions for hermetic Pb batteries

- It is important to maintain correct polarity – do not switch the poles, keep contacts clean.
- Use them only for electrical appliances, which they are intended for.
- Hermetic Pb batteries cannot be replaced by common car or motorcycle batteries.
- If the battery is overcharged during using the original charger, the charger is damaged. Immediately stop using the defective charger and hand the charger over to professional service for repair.
- **For charging the PB batteries it is not possible to use chargers for common car and motorcycle batteries or chargers for NiCd, NiMh or other types of batteries.**
- Protect the batteries against short-circuit, do not overload or heat the batteries, do not throw them into fire, do not open, deform or damage them.
- Hand the old batteries in to the collection place.

If the batteries are damaged by improper use or **by failure to follow principles mentioned above, the warranty cannot be applied!** To determine the cause of battery fault in order to claim warranty, the seller reserves the right to test the **conditions of the operation**. If im- proper conditions are found out, **the work connected with the control and measurement of the conditions will be charged.**

12. Circuit diagrams

12.1. FSTronic IRC-FI – Basic connection terminal X4

12.2. FSTronic IRC-FI – control board DPS

12.3. FSTronic IRC-FI – motor with IRC sensor

12.4. FSTronic IRC-FI – connection of smoke/heat detectors

12.5. FSTronic IRC-FI – battery module

12.6. FSTronic IRC-FI – connection of safety edge OSE + safety sensor passage door

12.7. FSTronic IRC-FI – connection of different types of light curtains

12.8. FSTronic IRC-FI – connection of optocell, connection of safety sensor gate lock

12.1. FSTronic IRC-FI

Basic connection terminal X4

FSTRONIC IRC-FI

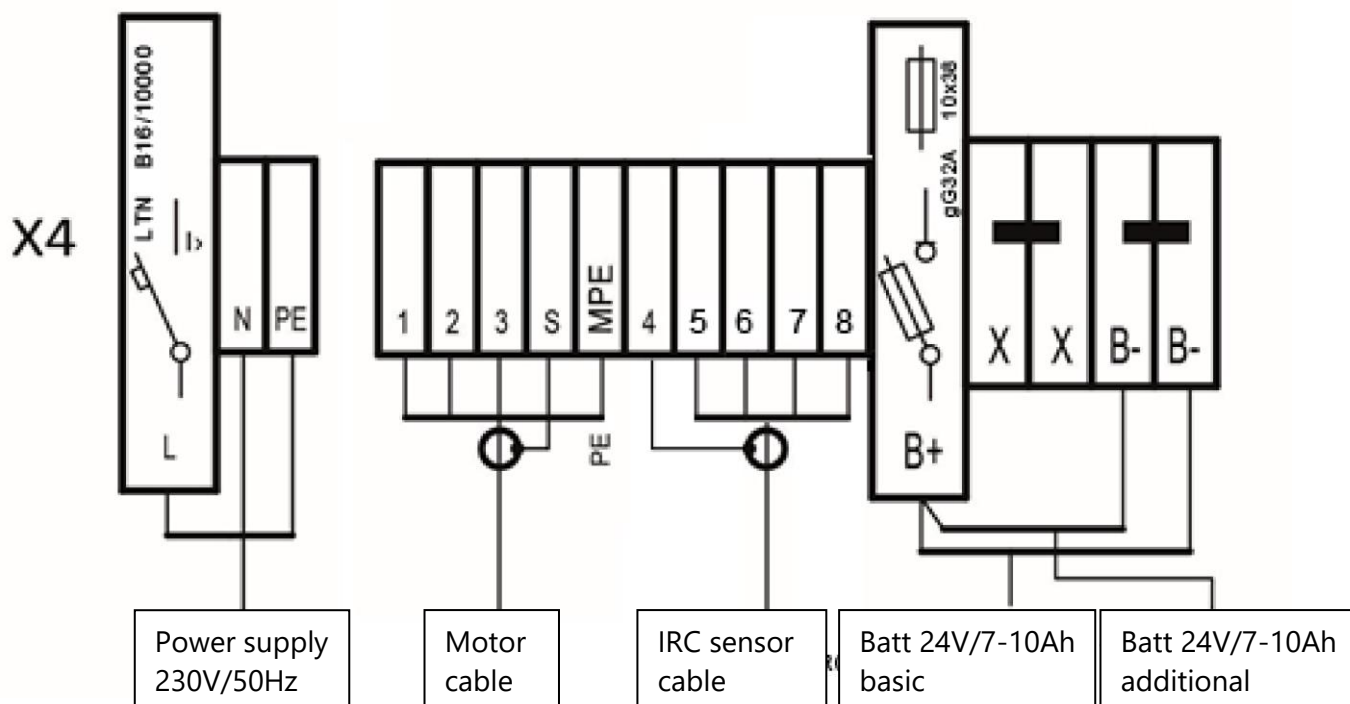

12.2. FSTronic IRC-FI

CONTROL BOARD DPS

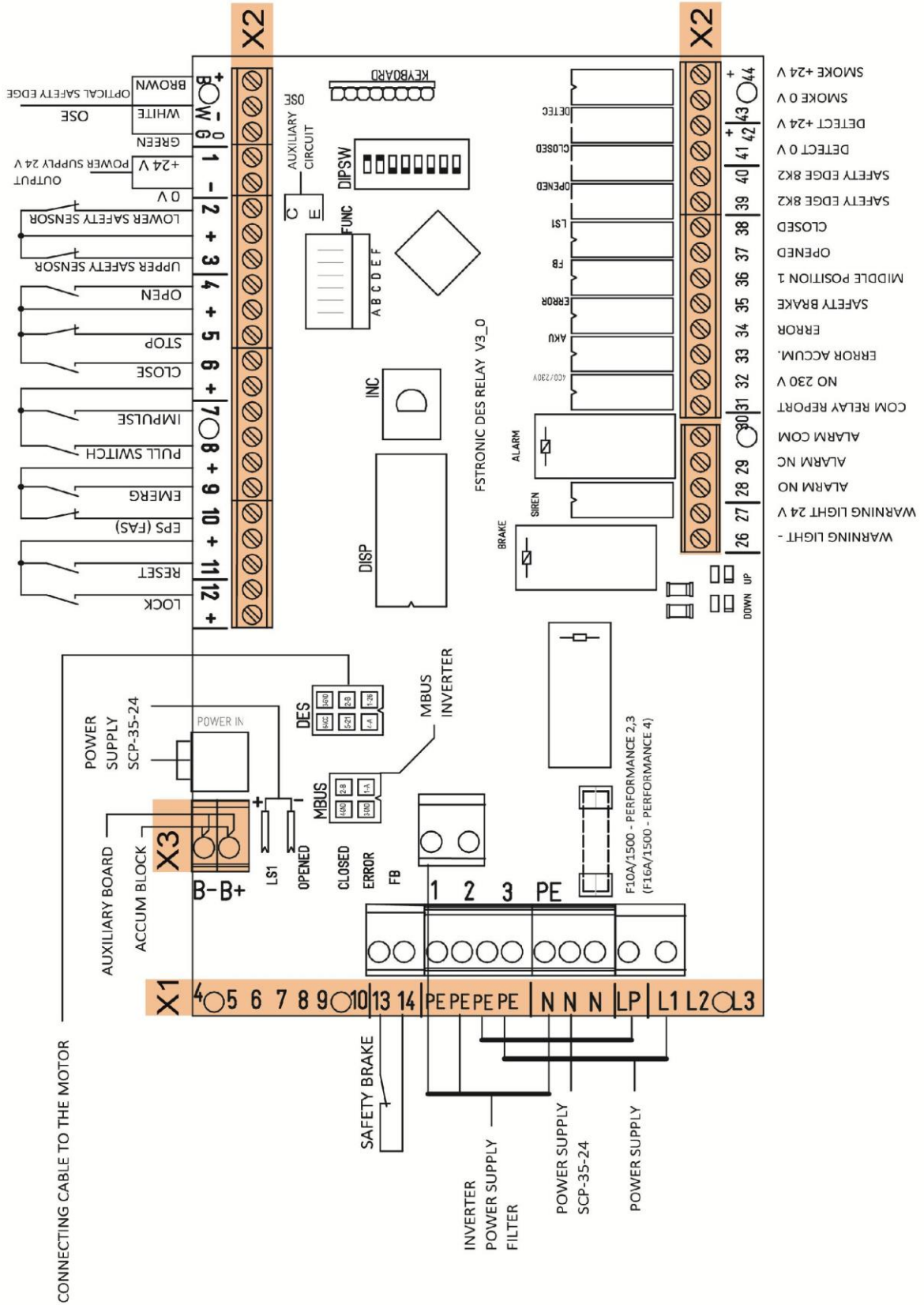

12.3. FSTronic IRC-FI

Motor with IRC sensor

terminal X4

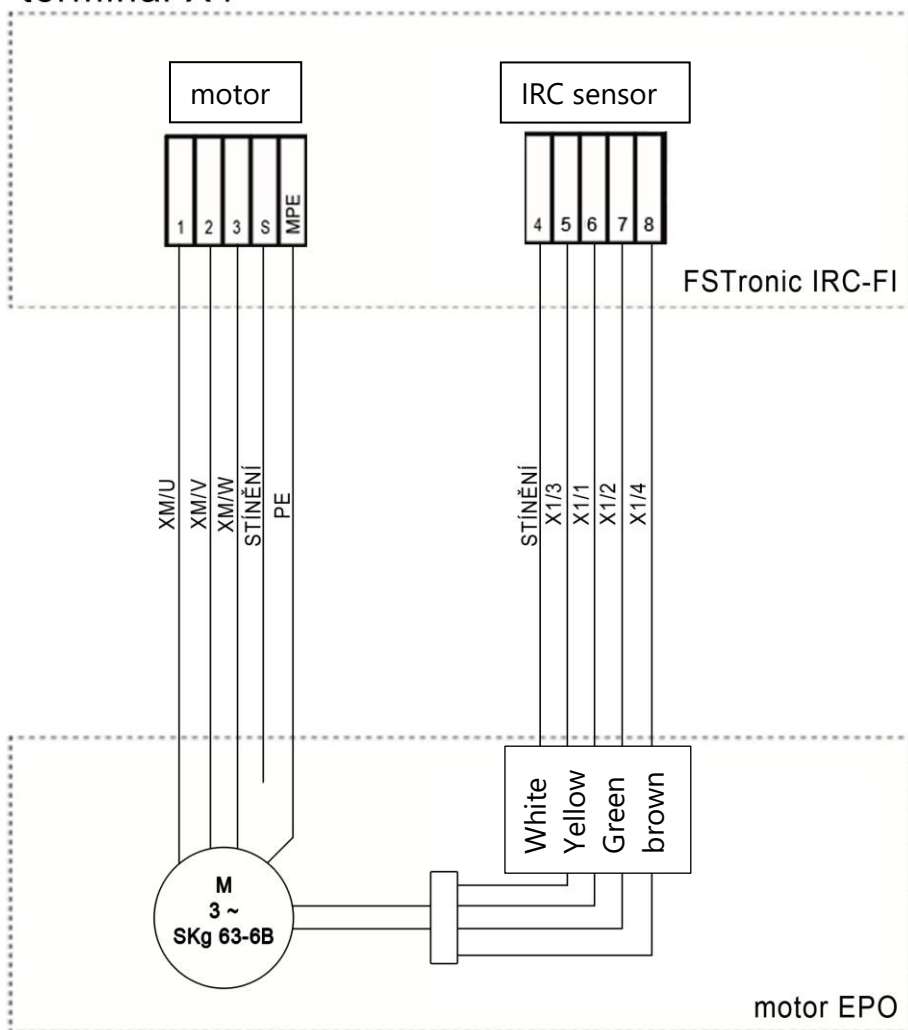

12.4. FSTronic IRC-FI

CONNECTION OF FIRE DETECTORS

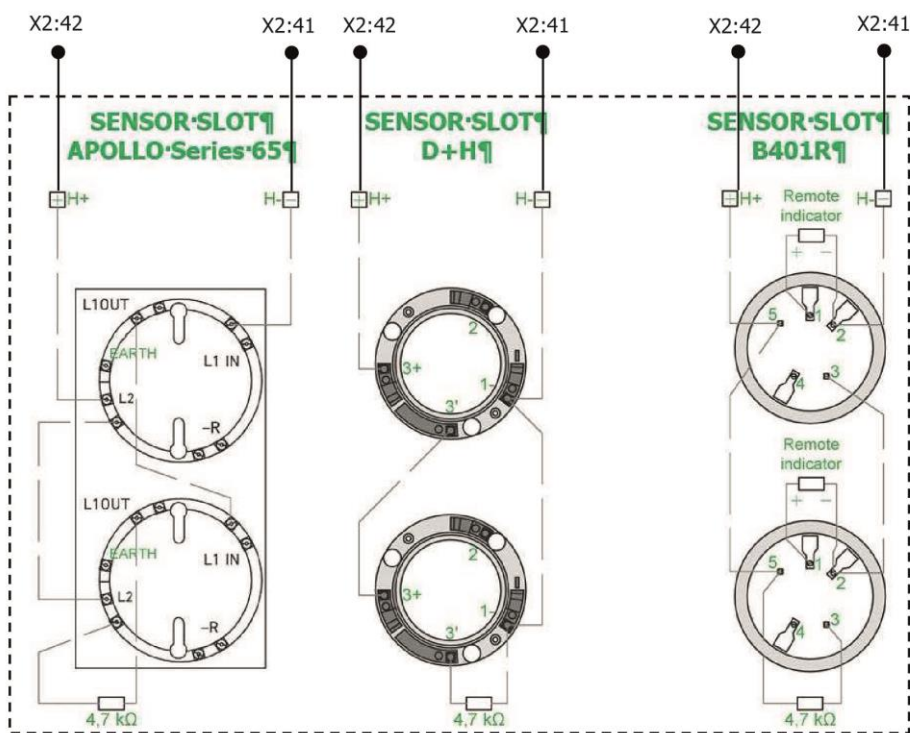
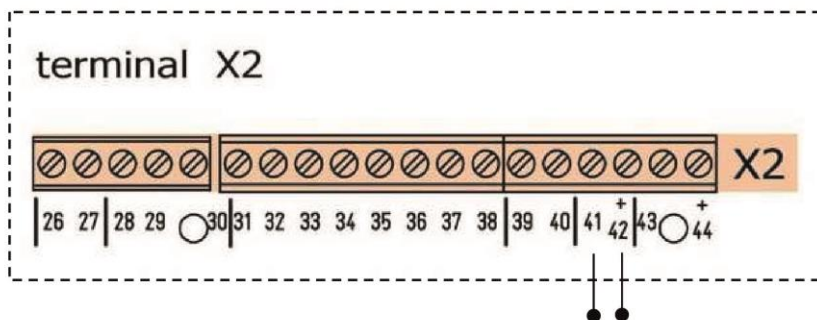

12.5. FSTronic IRC-FI

Connection of additional battery module

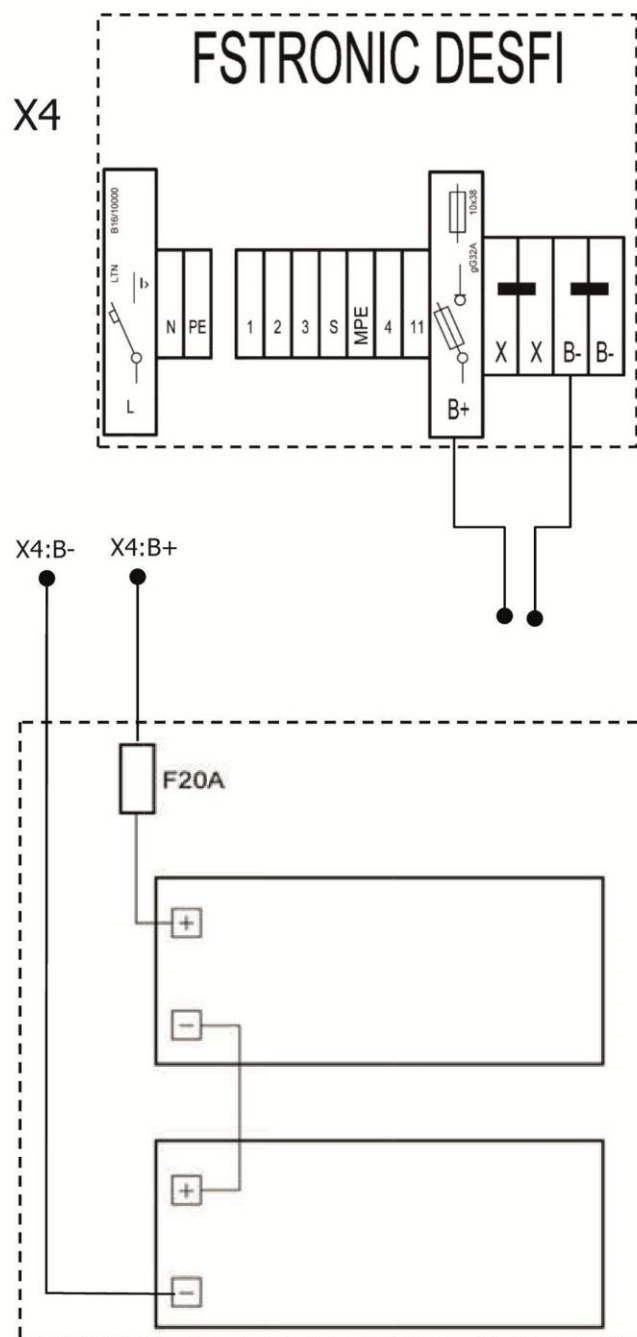

12.5. FSTronic IRC-FI

Connection of safety edge OSE + safety contact of passage door

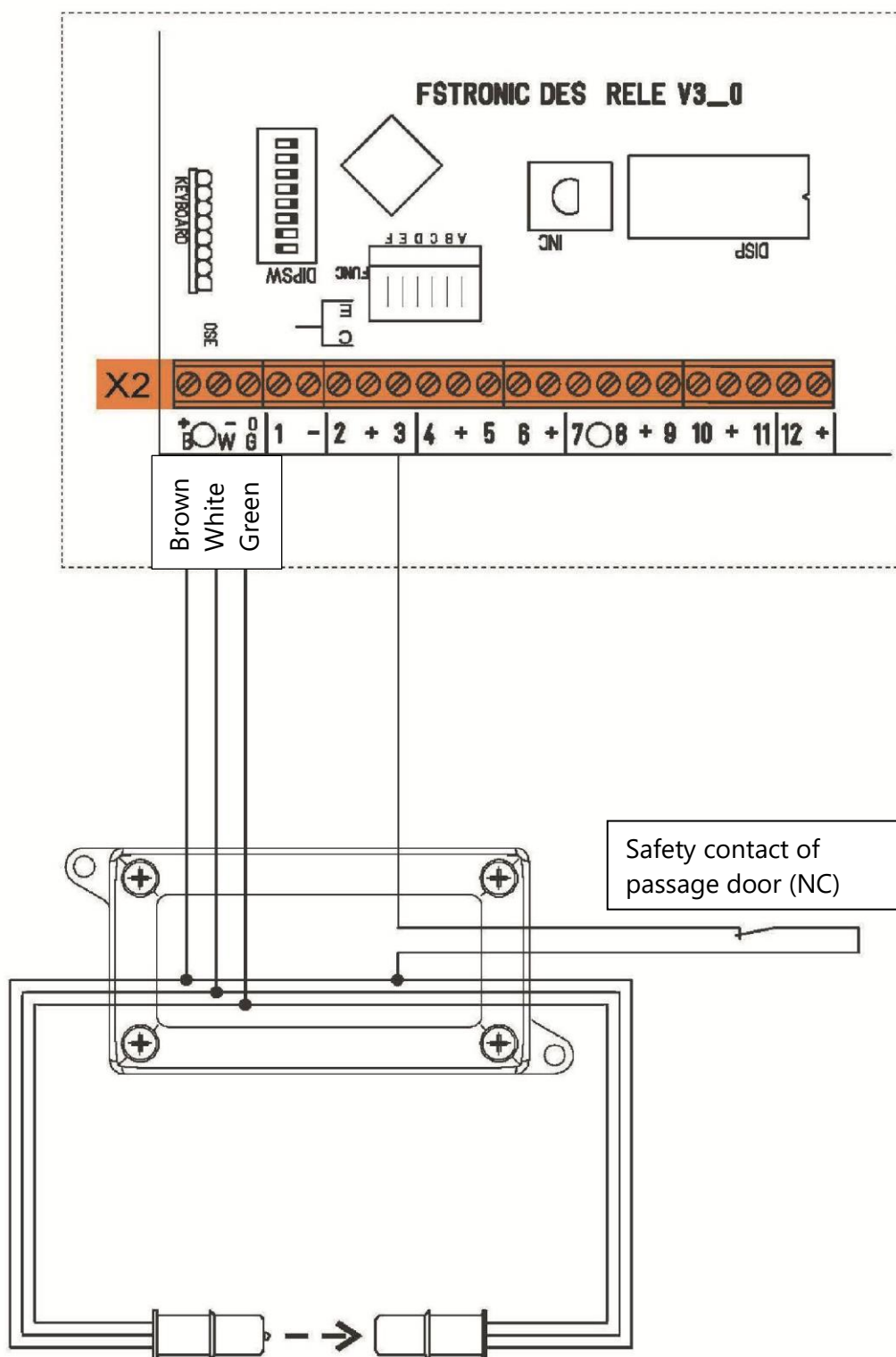

12.6. FSTronic IRC-FI

Connection of different types of light curtains

Cegard Mini SY2000:

Cegards Mini SY2000

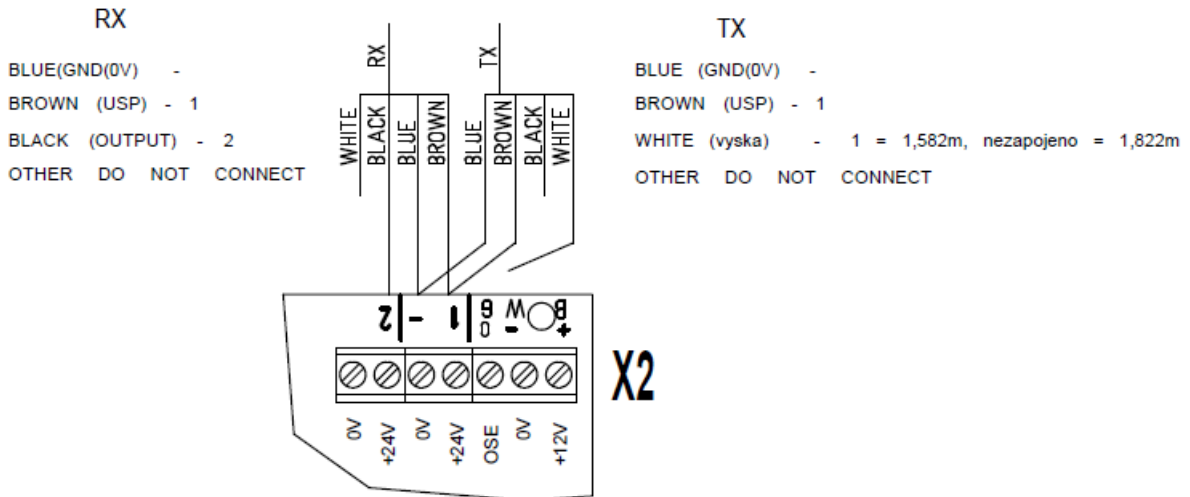

LIGI-07 OSE:

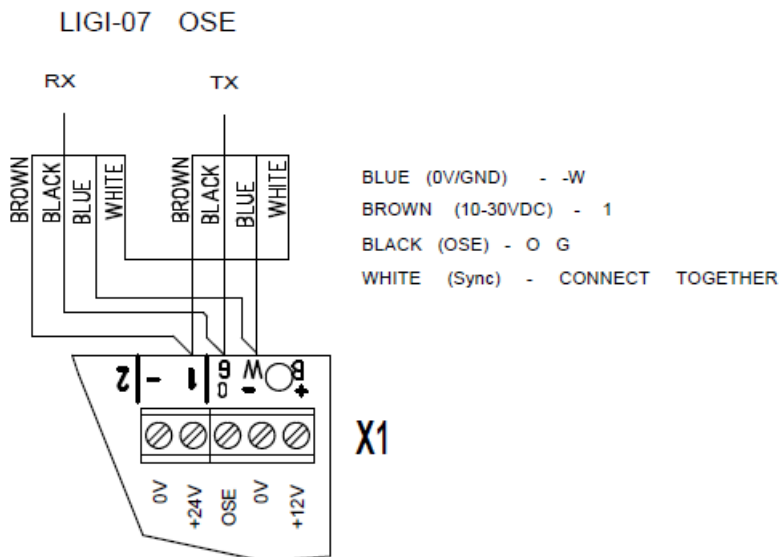

activate input OSE - DIP8 set to ON

GridScan PRO SY 2000 FSS:

GridScan PRO SY 2000 FSS

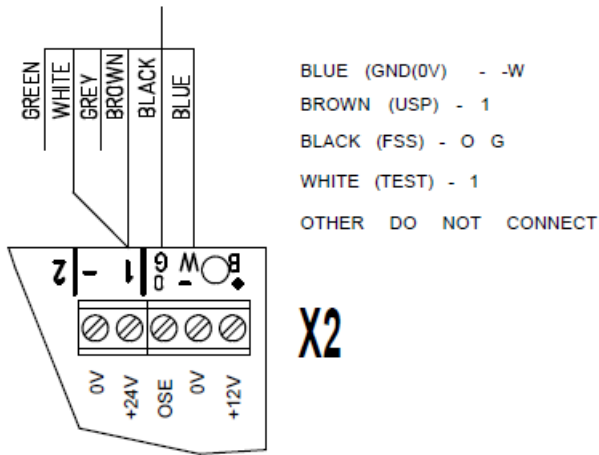

activate input OSE- DIP 8 set to ON

GridScan PRO SY 2000 LO:

GridScan PRO SY 2000 LO

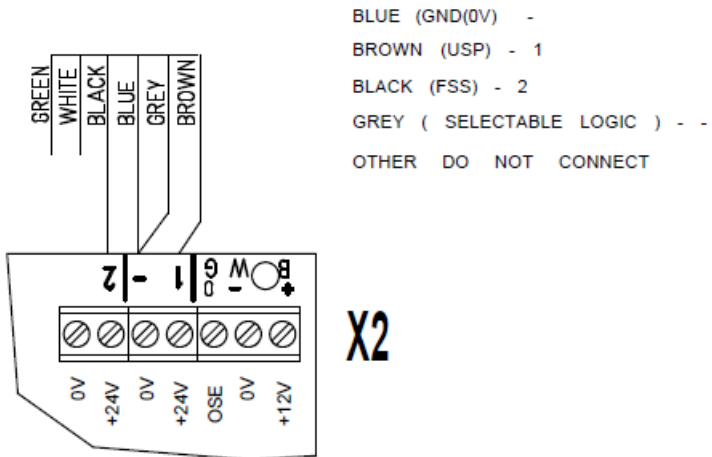

GridScan MINI FSS:

GridScan/MINI FSS

GRS/Mini - aa - bbbb - cc, dd, e, f, gg, hh
e = F

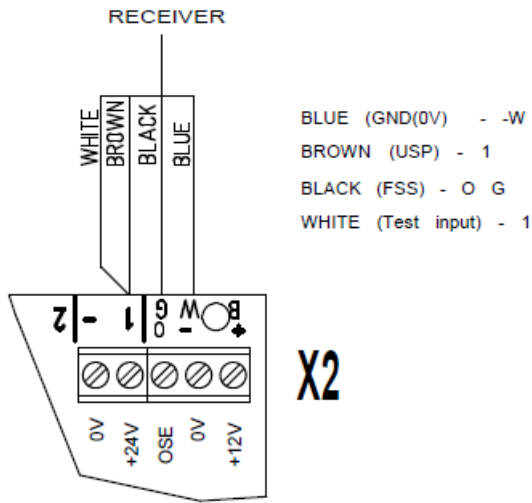

ACTIVATE INPUT OSE - DIP 8 set ON

GridScan MINI PNP/NPN:

GridScan/MINI PNP/NPN

GRS/Mini - aa - bbbb - cc, dd, e, f, gg, hh
e = N

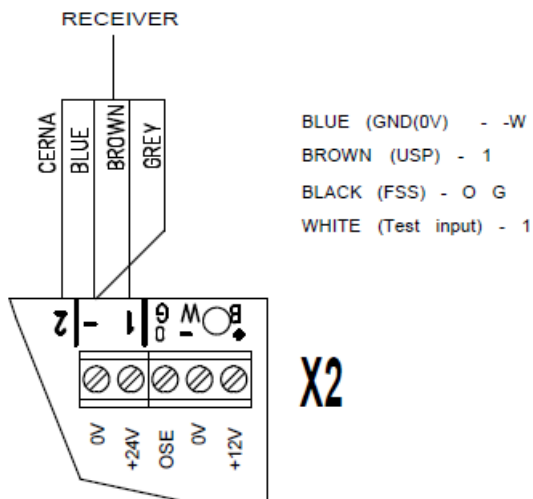

12.8. FSTronic IRC-FI

Connection of optocell WL 280-2P1131:

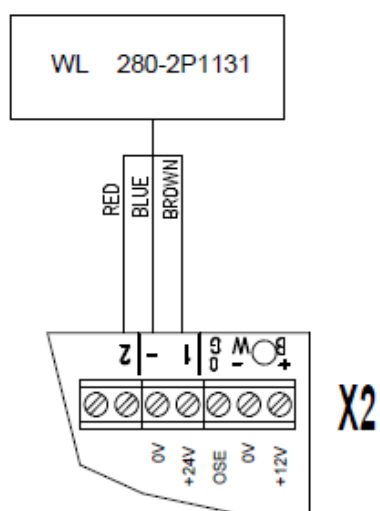

Connection of gate lock sensor – induction sensor OMRON EA2-M12:

